



RIGA TECHNICAL
UNIVERSITY

Oļegs Jakovļevs

ANALYSIS OF DYNAMIC PROCESSES IN CRYOSTATS WITH ELECTROMACHINE COOLING

Summary of the Doctoral Thesis



RTU Press
Riga 2019

RIGA TECHNICAL UNIVERSITY
Faculty of Mechanical Engineering, Transport and Aeronautics
Institute of Mechanics and Mechanical Engineering

Oļegs Jakovļevs

Doctoral Student of the Study Programme “Engineering Technology, Mechanics and
Mechanical Engineering”

**ANALYSIS OF DYNAMIC PROCESSES IN
CRYOSTATS WITH ELECTROMACHINE
COOLING**

Summary of the Doctoral Thesis

Scientific supervisor
Professor Dr. habil. sc. ing.
JĀNIS VĪBA

RTU Press
Riga 2019

Jakovļevs, O. Analysis of Dynamic Processes in Cryostats With Electromachine Cooling. Summary of the Doctoral Thesis. Riga: RTU Press, 2019. 31 p.

Published in accordance with the decision of RTU Promotion Council "P-04" of 10 June 2019, Minutes No. 10.

The Doctoral Thesis is developed with the financial support of the doctoral research grant of RTU and Faculty of Mechanical Engineering, Transport and Aeronautics.

ISBN 978-9934-22-340-2 (print)
978-9934-22-335-8 (pdf)

DOCTORAL THESIS PROPOSED TO RIGA TECHNICAL UNIVERSITY FOR THE PROMOTION TO THE SCIENTIFIC DEGREE OF DOCTOR OF ENGINEERING SCIENCES

To be granted the scientific degree of Doctor of Engineering Sciences, the present Doctoral Thesis has been submitted for the defence at the open meeting of RTU Promotion Council on September 19, 2019 16.00 at the Faculty of Mechanical Engineering, Transport and Aeronautics of Riga Technical University, Paula Valdena street 1, Room 101.

OFFICIAL REVIEWERS

Professor Dr. sc. ing. Vitālijs Beresņevičs
Riga Technical University, Latvia

Director of the Institute for Mechanics of Materials, Dr. sc. ing. Egils Plūme
University of Latvia, Latvia

Leading Researcher, Dr. habil. sc. ing. Vitālijs Krupeņins
IMASH RAN, Russia

DECLARATION OF ACADEMIC INTEGRITY

I hereby declare that the Doctoral Thesis submitted for the review to Riga Technical University for the promotion to the scientific degree of Doctor of Engineering Sciences is my own. I confirm that this Doctoral Thesis had not been submitted to any other university for the promotion to a scientific degree.

Oļegs Jakovļevs (signature)

Date:

The Doctoral Thesis has been written in Latvian. It consists of Introduction; 7 Chapters; Conclusions; 87 figures; 19 tables; 4 appendices; the total number of pages is 130. The Bibliography contains 72 titles.

CONTENTS

TOPICALITY	5
AIM OF THE THESIS.....	5
RESEARCH OBJECT	5
RESEARCH HYPOTHESIS.....	6
RESEARCH NOVELTY	6
PRACTICAL APPLICATION OF THE THESIS	6
PUBLICATIONS	7
STRUCTURE OF THE THESIS AND MAIN RESULTS	8
THESIS FOR ASSERTION.....	8
1. OBJECT OF THE RESEARCH	9
2. RESEARCH GOAL.....	10
3. A COMPLEX APPROACH TO DESIGN OF GAMMA SPECTROMETERS WITH EMC	14
4. MODELLING OF HEAT PROCESSES IN CRYOSTATS WITH EMC	15
5. RESONANCE EVALUATION IN CRYOSTAT WITH EMC	25
6. APPROBATION OF RESULTS	28
7. CONCLUSIONS.....	29
THE BIBLIOGRAPHY	31

TOPICALITY

The topicality of the Thesis is determined by the ever-increasing need for new efficient identification devices to control the radiation level of nuclear facilities and nuclear waste disposal sites, as well as the global monitoring of land, air and water environments with a view to preventing possible pollution. The new identification devices for electromachine coolers (EMC) use high purity germanium (HPGe) gamma detectors for cooling to cryogenic temperatures. This allows to create cryostats for gamma spectrometers with more convenient and safe cooling instead of liquid nitrogen application. This aspect is particularly important in terms of productivity due to the constantly increasing number of personnel using, monitoring and operating similar equipment worldwide.

AIM OF THE THESIS

The aim of the Thesis is to study the dynamic processes of cryostat with electromachine cooling, to modernize the existing equipment based on the obtained results, and to develop principally new gamma identification equipment. To this end, the following tasks were solved.

1. Scientific equipment with high purity germanium (HPGe) gamma detectors was analyzed, researched and evaluated.
2. Thermal processes and mechanical vibrations in dynamic processes in the gamma spectrometer cryostats with an electromachine cooler (EMC) were considered, analyzed.
3. Options and recommendations for reducing the negative impact of some EMC characteristic features were analyzed.
4. Technical task in the form of a block diagram for a complex approach to constructing gamma spectrometer cryostats with electromachine coolers was developed and described.
5. Methodology, modeling calculations with computer program *MathCAD* and with *Solidworks*, as well as experiments for modeling of heat processes in cryostats with electromachine coolers have been developed.
6. Modal analysis was performed with *Solidworks* computer program and experimental research for resonance assessment in cryostat with electromachine cooler was carried out.
7. Modern crystals of electromagnetic coolers for modern and developed Solidworks environments were developed.

RESEARCH OBJECT

The object of the research is the thermal and mechanical models of cryostat with high purity germanium (HPGe) detectors and electromachine coolers (EMC), whose movement and processes are described by systems of differential equations of mechanical and thermal engineering using modern computer programs.

RESEARCH HYPOTHESIS

1. The work developed a dynamic heat model of cryostat with electromachine coolers and thermal shields, which is compiled using a thermoelectric analogy hypothesis.
2. The thermal shield calculation model was developed on the basis of the hypothesis of the system of differential equations of classical mathematics; temperature decomposition on the detector thermal shield was calculated.
3. The modal analysis of detector supports and detector cover was performed with the help of *Solidworks* program's fundamental hypothesis network.
4. Theoretical hypotheses about the reliability of the simulation results have been verified by experimental testing using an electrodynamic vibrating device *VBЭ-1-004*.
5. A parametric string of specially certified HPGe detectors that is used in gamma spectrometers with electromachine coolers was used.
6. An evaluation of the cryostat transition cooling process was performed in *Solidworks* and verified by experimentally obtained real cryostat during cooling.

RESEARCH NOVELTY

The novelty of the research is based on the following results:

- 1) Based on the energy balance equation, a mathematical model of cryostat with the cooling of an electromachine has been compiled.
- 2) A model described by a system of non-linear differential equations was solved, analyzed and optimized.
- 3) Results describing the temperature distribution on the surface of the thermal shield were obtained. This allows to determine the effect of heat supply and control, depending on the conductivity of the molecular residue gas cryostat.
- 4) New results have been obtained on the efficient reduction of heat flow to the detector using a thermal shield (not only in the high but also in the average vacuum area).
- 5) Modal analysis of the gamma spectrometer cryostat was performed and a basic system frequency passport was obtained, which helped to identify the source of the microphone effect.

PRACTICAL APPLICATION OF THE THESIS

Practical application of the Thesis includes an analysis of existing gamma spectrometers, and modernization and development of new gamma spectrometers. As a result, new gamma spectrometers with a specific application and type have been upgraded and developed:

1. Portable gamma spectrometers for field applications.
2. Teaching and scientific laboratory work gamma spectrometers.
3. Laboratory and industrial gamma spectrometers with hybrid cooling type.

The developed gamma spectrometers have found application in China, Japan, Russia, India, Thailand and Singapore. Some spectrometers are used in space technologies within the ESA project.

PUBLICATIONS

There are 15 publications on the topic, 7 of which have been indexed in *Scopus*, 7 publications have been published in international scientific journals. Works were presented in international conferences in Latvia, Russia, the Czech Republic, France, Bulgaria, Thailand.

Publications in scientific journals

1. Kondratjev, V., Pchelintcev, A., **Jakovļevs, O.**, Sokolov, A., Gostilo, V., Owens, A. Performance of a Miniature Mechanically Cooled HPGe Gamma-Spectrometer for Space Applications. *Journal of Instrumentation*, 2018, Vol. 13, January 2018, pp. 1–13. e-ISSN 1748-0221. doi: 10.1088/1748-0221/13/01/T01002.
2. **Jakovļevs, O.**, Pchelintcev, A., Malgin, V., Sokolov, A., Gostilo, V. Development of Miniaturized HPGe Spectrometers for Unmanned Aerial Vehicles. *Journal of Instrumentation*, 2018, Vol. 13, Article number T06006. e-ISSN 1748-0221. doi: 10.1088/1748-0221/13/06/T06006.
3. **Jakovļevs, O.**, Malgin, V., Gostilo, V. Разработка унифицированного спектрометрического модуля на основе ОЧГ-детекторов с электромашинным охлаждением. *Nuclear and Radiation Safety*, 2018, 03. ISSN 2073-6231.
4. **Jakovļevs, O.**, Malgins, V., Vība, J. Modal Analysis of HPGe Detector Assembly in Gamma-ray Spectrometers. *Vibroengineering PROCEDIA*, 2017, Vol. 16, pp. 61–66. ISSN 2345-0533. doi:10.21595/vp.2017.19205.
5. Kondratjev, V., Gostilo, V., Owens, A., **Jakovļevs, O.**, Vība, J. Vibration Characteristics of Miniature Stirling Electric Coolers. *Vibroengineering Procedia*, 2016, Vol. 8, pp. 409–413. ISSN 2345-0533.
6. Tkaczyk, A., Malgins, V., **Jakovļevs, O.**, Jeltsov, M., Primagi, P. Development and CFD Simulation of Cryostat Thermal Shielding for a Portable HPGe Gamma Spectrometer. *Applied Thermal Engineering*, 2019, Vol. 1 No.1, pp. 1–17. ISSN 1359-4311.
7. Pchelintcev, A., Lupilov, A., Nurgaleev, R., **Jakovļevs, O.**, Sokolov, A., Gostilo, V., Owens, A. A Miniature Compact HPGe Gamma-Spectrometer for Space Applications. *Journal of Instrumentation*, 2017, Vol. 12, pp. 1–9. e-ISSN 1748-0221. doi:10.1088/issn.1748-0221.
8. **Jakovļevs, O.**, Malgins, V., Vība, J. Stirlinga cirkļa rotoru elektrodzesētāju vibrāciju analīze. No: RTU. Pieņemts publicēšanai: 2017, 1.–8.lpp.

Full-text publications in conference proceedings

1. **Jakovļevs, O.**, Malgins, V., Vība, J. Thermal Modeling of Cooldown Processes in Portable HPGe Spectrometers. No: Recent Trends in Engineering and Technology (RTET-17): 6th International Conference, France, Paris, 25–26 April 2017. pp. 92–98. ISBN 978-81933894-2-3.

2. **Jakovļevs, O.**, Vība, J., Gostilo, V., Jefremova, N. Computer Design of Precise Spectrometric Equipment with Innovative Cooling Systems. No: 2nd Scientific Congress “Innovations in Engineering 2016”: Scientific Proceedings, Bulgaria, Varna, 20–23 June 2016. Scientific-Technical Union of Mechanical Engineering, pp. 34–36. ISSN 1310-3946.
3. **Jakovļevs, O.**, Vība, J., Gostilo, V., Jefremova, N. Simulation and Design of Radiation Shielding and Collimation Systems for the Precise Gamma-Spectrometric Equipment. No: Proceedings of International Conference on Innovative Technologies, Czech Republic, Prague, 6–8 September 2016. University of Rijeka, 2016, pp. 23–26. ISSN 1849-0662.
4. **Jakovļevs, O.**, Malgins, V., Vība, J. Исследования вибрационных характеристик блока детектора портативного спектрометра с электромашинным охлаждением. No: Scientific Proceedings of the Scientific-Technical Union of Mechanical Engineering, Bulgaria, Borovets, 12–15 December, 2016. Scientific-Technical Union of Mechanical Engineering, pp. 36–39. e-ISSN 1310-3946.
5. **Jakovļevs, O.**, Vība, J., Gostilo, V. Разработка систем охлаждения полупроводниковых детекторов гамма-излучения на основе электромашинных охладителей. No: XXVII Международная Инновационно-ориентированная конференция молодых учёных и студентов МИКМУС-2015: труды конференции, Russia, Moscow, 2–4 December, 2015. ИМАШ РАН, pp. 265–268.
6. Tkaczyk, A., Jeltsov, M., Malgins, V., **Jakovļevs, O.**, Priimagi, P. Cooperative Development of a Handheld Spectrometer for Radiation Detection in the Context of the Estonia-Latvia “Hadede” Project. No: LU 77th International Scientific Conference, Latvia, Riga, 8 February 2019. Riga: University of Latvia, pp. 1–2.
7. **Jakovļevs, O.**, Malgins, V., Gostilo, V., Vība, J. Constructive and Technological Aspects of the Development of Cryostats for HPGe Detectors with Electric Cooling. No: European Planetary Science Congress 2017: EPSC Abstracts. Vol. 11, Latvia, Riga, 17–22 September, 2017, pp. 1–2.

STRUCTURE OF THE THESIS AND MAIN RESULTS

The work consists of an introduction, 7 chapters, which include literature review, calculation and experimental parts. The main conclusions, and the list of references used in the thesis. The total number of pages is 130; there are 87 figures, and 19 tables. The Bibliography lists 72 literature sources. The Thesis has 4 appendices.

THESIS FOR ASSERTION

1. Mathematical model of the gamma spectrometer cryostat with the EMC cooling and results on the effective reduction of the heat flow to the detector by means of a thermal shield (not only in the high but also in the medium vacuum area).
2. Gamma spectrometer cryostat modal analysis and basic system frequency passport with which microphone source detection becomes possible.
3. Practical application that includes analysis, modernization for existing gamma spectrometers, and development of new gamma spectrometers.

1. OBJECT OF THE RESEARCH

In **Chapter 1** of the Thesis, previous researches are analyzed and scientific equipment with high purity germanium (HPGe) detectors is evaluated.

The unique possibilities of modern gamma spectrometry for various research areas are described. Semiconductor detectors from high purity germanium (HPGe) used in gamma spectrometers are marked as leaders [1]. The main features of these detectors are the need to cool the germanium monocrystal up to liquid nitrogen temperature to increase its sensitivity. The cooling of HPGe detectors up to the liquid nitrogen temperature with the use of Dewar vessel is mainly a threat to human life. One of the directions for solving this problem is the development of HPGe gamma spectrometers without the use of liquid nitrogen as an HPGe detector cooler. The emergence of small-scale, safe and fairly powerful electric machine coolers (EMC) on the market [2], [3] revealed a development perspective of applying them to a wide range of gamma spectrometric equipment (based on HPGe detectors) (Fig. 1.1). Using EMC gives the advantage of creating handy portable gamma spectrometers. At the same time, the development of HPGe spectrometers on the basis of EMC introduces their complex tasks defined by the limited EMC cooling capacity and vibrations transmitted from EMC. Nonetheless, the benefits of EMC, such as reducing gamma spectrometer gauge and weight, comfort and safety in use, the ability to install the device in a hazardous environment without the need for maintenance, and work in any spatial condition are indisputable priorities when developing HPGe gamma spectrometers on EMC basis.

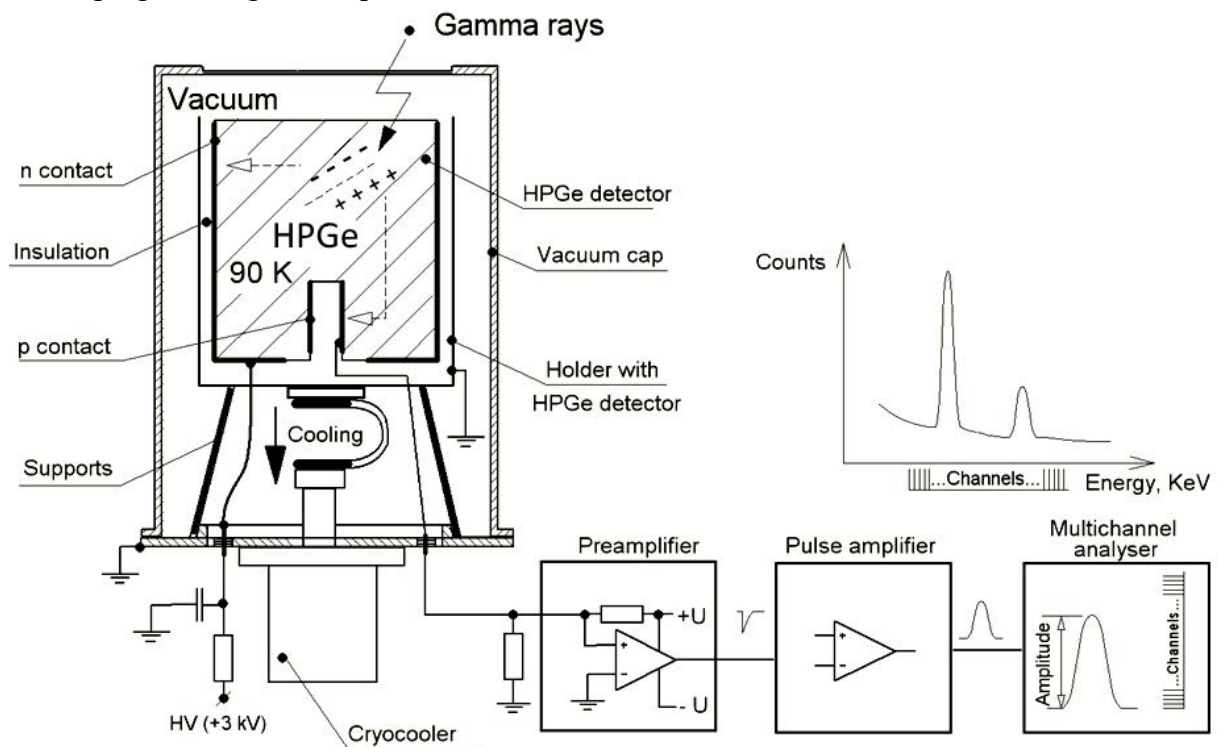

Fig. 1.1. Gamma spectrometer structure based on HPGe detectors.

2. RESEARCH GOAL

Chapters 2 and 3 of the Thesis deals with the analysis of heat processes and mechanical vibrations in dynamic processes in the cryostats of gamma spectrometers with electromachine coolers (EMC).

One of the most serious problems with cryostats with EMC is their limited cooling capacity, which makes it a challenge to minimize heat transfer from the ambient to the cooled detector (2.1). Three components that are depicted in Fig. 2.1 may be highlighted in the heat transfer structure of the cryostat with HPGe detector (Fig. 2.1) (Table 2.1).

Chapters 2 and 3 deal with the physical processes of standard construction with EMC cooled cryostat. The focus is on cryostat with EMC specific processes based on dynamic heat and mechanical models.

It is noted that the main sources of EMC vibration are the electromagnetic compressor and the expansion tube with the piston extractor [3], [4]. It has been shown that EMC operation at reduced power reduces its vibroactivity by more than 40 % [5], [6]. Cryostat with HPGe detector and main oscillation systems of EMC typical design whose mechanical oscillations cause a microphone effect [7], [8], which greatly reduces the energy resolution of the gamma spectrometer are analysed. There is a wide range of detectors that can be used with different efficiency, which puts the complementary task of developing a unified construction for the detector holder support [9], [10]. Based on the analysis of EMC and the applied HPGe detectors, a parametric string was proposed (Table 2.2). Opportunities are analyzed and recommendations are developed for reducing the negative effects of EMC vibrations (Fig. 2.2).

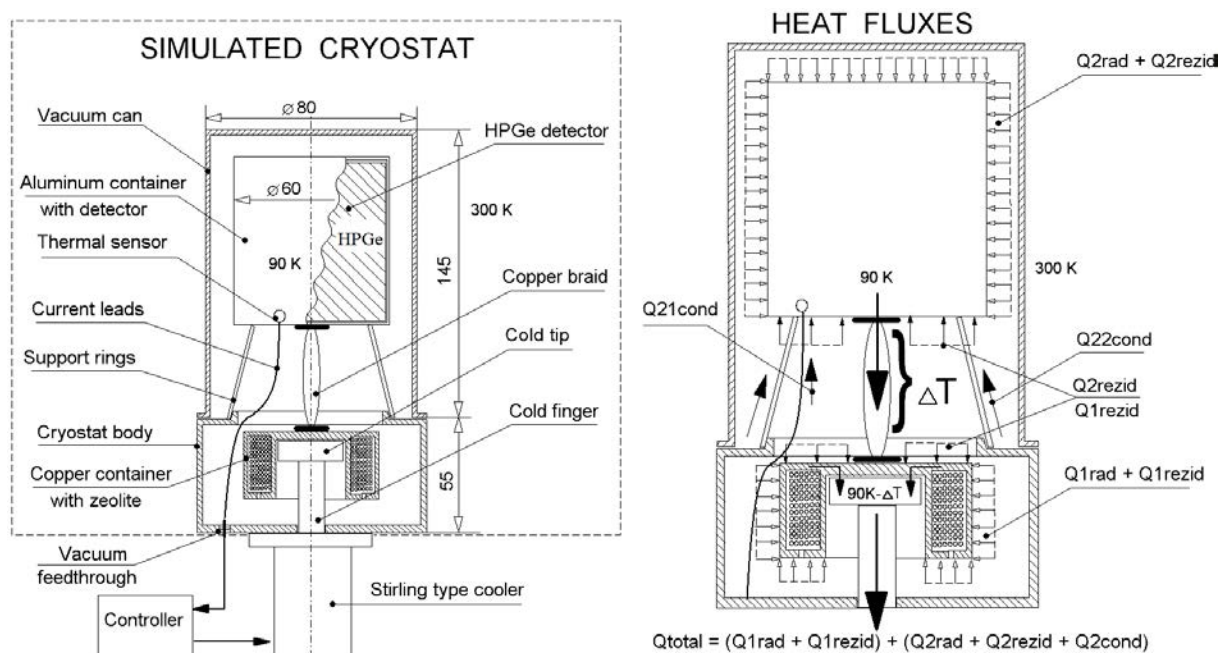

Fig. 2.1. Heat fluxes components in cryostat.

The total heat flow in the cryostat (2.1.) can be expressed in the following way:

$$Q_{\text{total}} = (Q_{1\text{rad}} + Q_{1\text{resid}}) + (Q_{2\text{rad}} + Q_{2\text{resid}} + Q_{2\text{cond}}), \quad (2.1)$$

where

$Q_{1\text{resid}}$ – heat transfer to the tank with a sorbent of the gas due to the conductivity of gases;

$Q_{1\text{rad}}$ – heat transfer to the tank with a sorbent at a loss due to the conductivity of gases;

$Q_{1\text{rad}}$ – heat transfer to the tank with sorbent due to heat radiation;

$Q_{2\text{resid}}$ – heat transfer at the detector holder due to the conductivity of gases;

$Q_{22\text{cond}}$ – heat transfer through detector holder supports;

$Q_{2\text{rad}}$ – heat transfer at the detector holder due to heat radiation.

Table 2.1

Heat Supply Components

No.	Heat Supply Components	Designation	Reduction methods
1.	Thermal conductivity of materials	$Q_{22\text{cond}}$	Use of materials with lower thermal conductivity; construction of supports with longer thermal bridge
2.	Thermal conductivity of residual gases	$Q_{1\text{resid}}$; $Q_{2\text{resid}}$	Reduction of gas leakage through seals; absorption of residual gases by getters
3.	Heat radiation	$Q_{1\text{rad}}$; $Q_{2\text{rad}}$	Improving surface quality for emission reduction; application of thermal shields

Table 2.2

A Set of EMC-HPGe Detector Parameters

		HPGe detector parameters																					
		10 %	15 %	20 %	30 %	40 %	50 %	60 %	80 %	100 %	125 %	160 %											
		Ø	H	Ø	H	Ø	H	Ø	H	Ø	H	Ø	H	Ø	H								
Effectivity		52	31	52	43	54	50	59	55	63	61	70	55	71	70	78	72	83	80	88	88	92	90
Geometry, mm		65.8	91.3	114.5	150.3	190.1	211.6	277.0	343.9	432.6	535.0	598.0											
Volume, cm ³		0.35	0.49	0.61	0.80	1.01	1.13	1.47	1.83	2.30	2.85	3.18											
Mass, kg		95	131	165	216	274	305	399	495	623	770	861											
Integral thermal mass, J/K		Spectrometric modules with EMC																					
Type and power of EMC; Maximum cryostat heat load		Miniature EMC, 0.5–1.0 W@80K <i>RICOR K508</i> ; <i>THALES RM3</i>																					
		Low power EMC, 1.0–2.0 W@80K <i>RJKOR K570</i> ; <i>AIM SF100</i>																					
		Cryostat heat load no more than 0.5 W																					
		Average power EMC, 2.0–5.0 W@80K <i>AIM SL400</i> ; <i>THALES LSF9589</i>																					
		Cryostat heat load no more than 1.5 W																					
		High power EMC, 5.0–15.0 W@80K <i>THALES LSF9340</i> ; <i>LIHAN TC4187</i> ; <i>LIHAN TC4189</i>																					
		Max cryostat heat load no more than 4 W																					
		Spectrometric modules with hybrid cooling (LN ₂ + EMC)																					
		High power EMC, 9.0–15.0 W@80K <i>THALES LSF9340</i> ; <i>LIHAN TC4189</i>																					
EMC type and power		Total heat load in cryostat and modular liquefaction no more than 3.0 W																					
Heat load																							

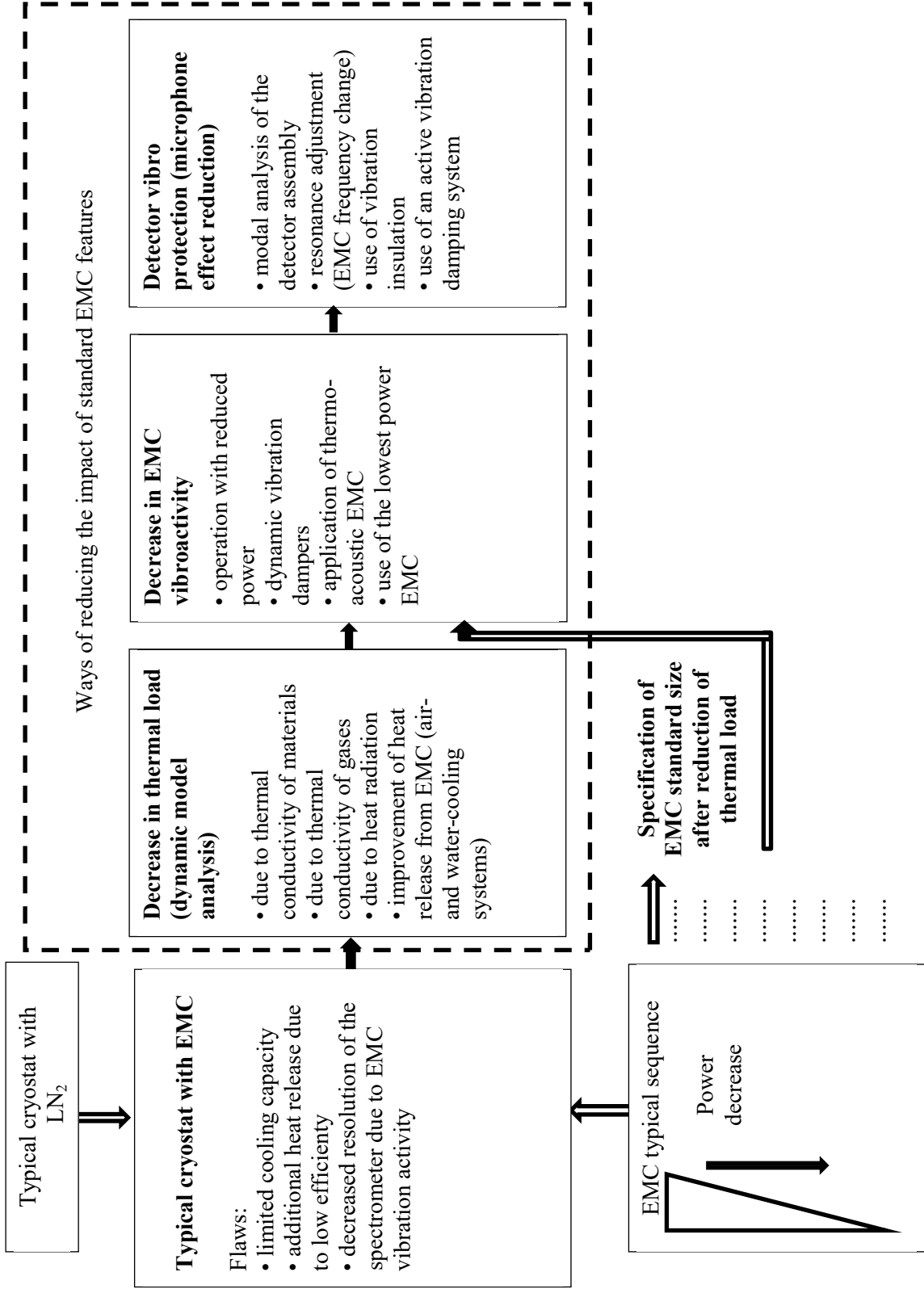

Fig. 2.2. Decrease in the effects of the standard features of electromachine cooling.

3. A COMPLEX APPROACH TO DESIGN OF GAMMA SPECTROMETERS WITH EMC

Chapter 4 develops and describes the technical goal in the form of a block diagram (Fig. 3.1) for a complex approach to constructing gamma spectrometers cryostats with electromachine coolers (EMC).

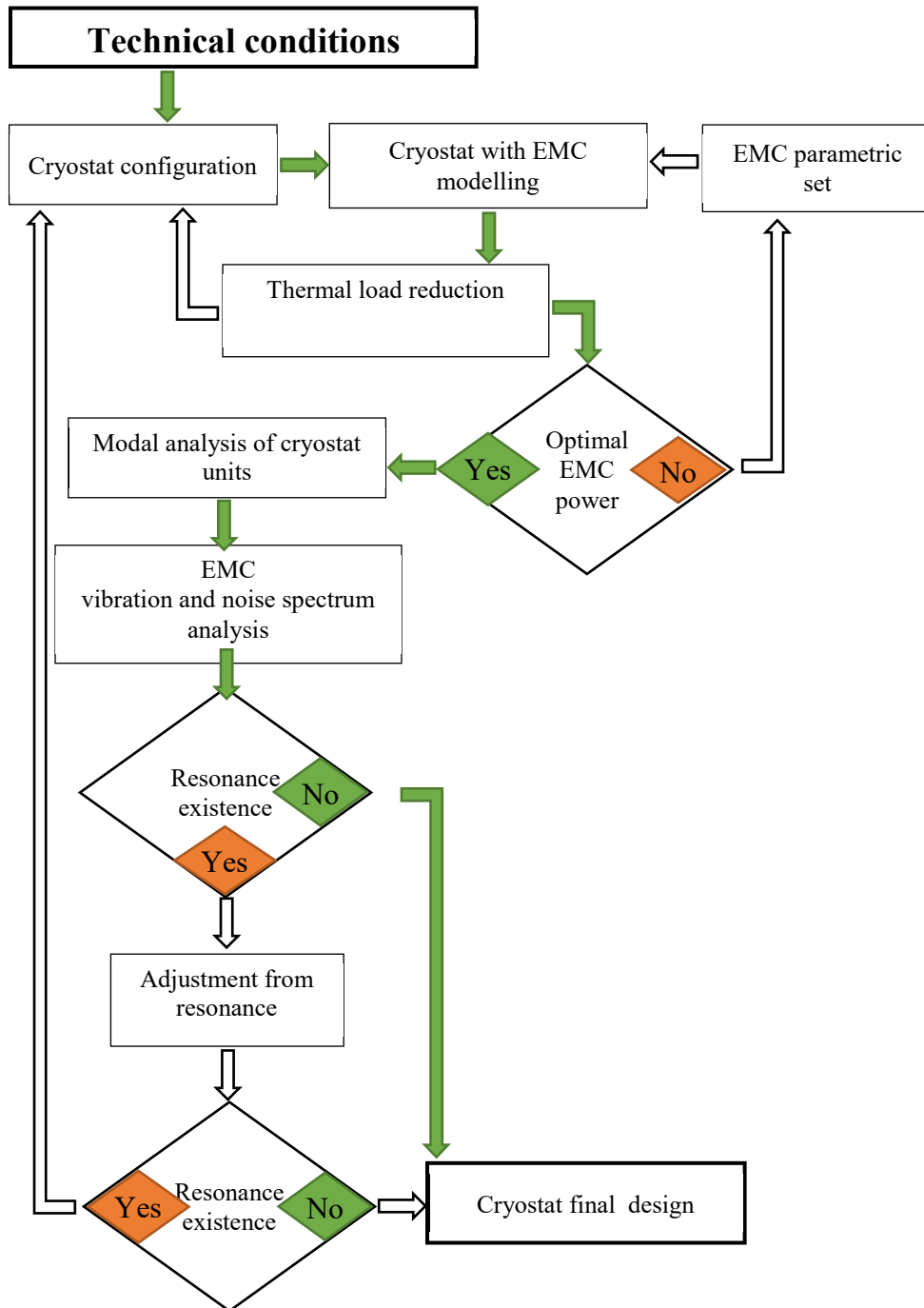

Fig. 3.1. Structure of complex approach for the design of gamma spectrometers cryostats with EMC.

4. MODELLING OF HEAT PROCESSES IN CRYOSTATS WITH EMC

Chapter 5 deals with dynamic heat processes in cryostats with EMC. Methodology has been developed and modeling calculations have been performed with *MathCAD* and *Solidworks* computer program, as well as experiments on modeling of heat processes in cryostats with electromachine coolers (EMC) were carried out.

A dynamic heat model of cryostat with electromachine coolers and thermal shields has been developed, which is compiled by a thermoelectric analogue method (Fig. 4.1). The main thermoelectric analogues are listed in Table 4.1. The model allows to evaluate the main heat processes that affect the cooling speed of the HPGe detector; it can be designed for calibration and testing of more complex models for calculations using finite element method.

Table 4.1

Thermoelectric Analogues

Heat parameters		Electric parametrs	
Heat flow	$P, (W)$	Current	$I, (A)$
Temperature	$\Theta, (K)$	Voltage	$U, (V)$
Thermal resistance	$R, (K/W)$	Resistance	$R, (\Omega)$
Thermal capacity	$C, (J/K)$	Capacity	$C, (F)$

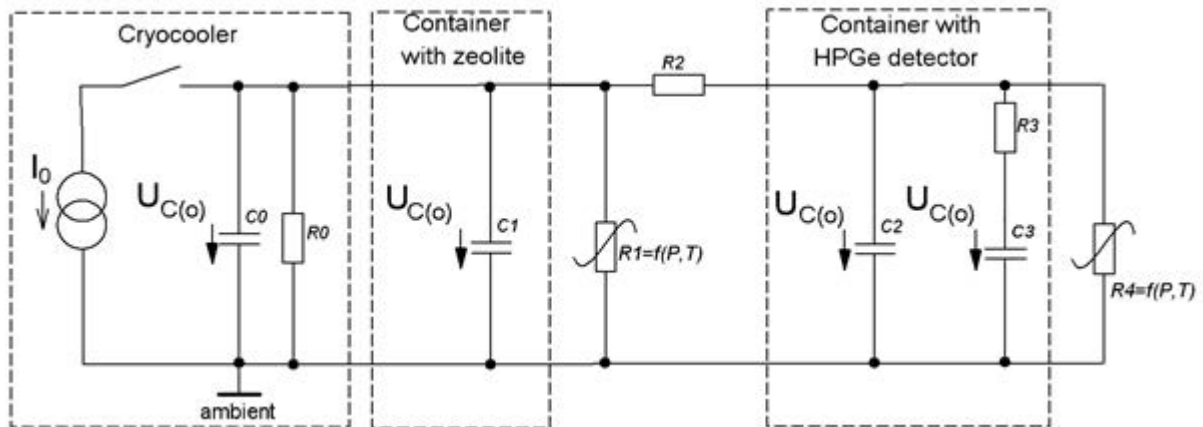

Fig. 4.1. Equivalent thermoelectric model of cryostat with EMC for cooling process analysis.

A model is developed (Fig. 4.2), which allows to evaluate the basic processes that affect cooling of HPGe using the thermal shield. Differential equations, which allow to calculate not only the stationary temperature of the cryostat components, but also the dynamics of their cooling process, are developed. An analytical solution with linear characteristics was obtained when the pressure in the cryostat was 10^{-2} mbar and higher.

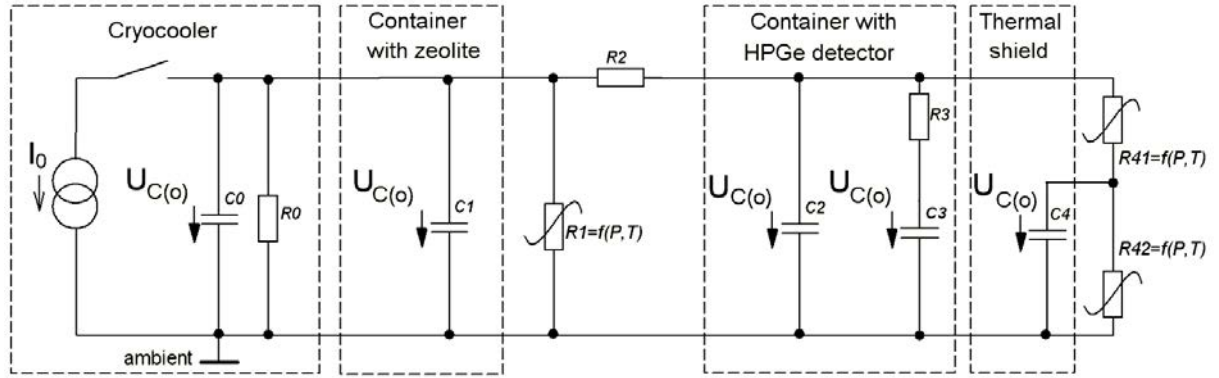

Fig. 4.2. Equivalent thermoelectric model for cryostat with EMC and thermal shield for cooling process analysis.

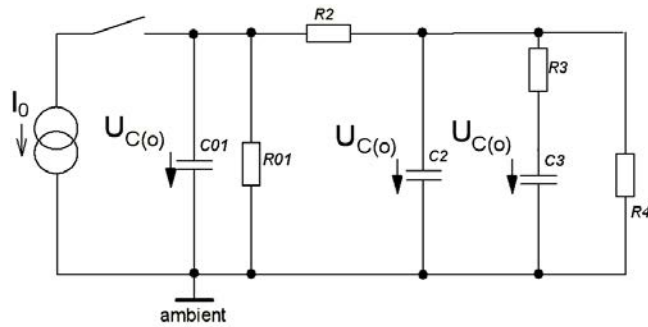

Fig. 4.3. Linearized equivalent cryostat with EMC model.

Equation system for the model (Fig. 4.3.):

$$\frac{dU_{C01}}{dt} = \frac{I_0}{C_{01}}; \quad \frac{U_{C01}}{R_{01}} = I_{R01};$$

$$\frac{dU_{C2}}{dt} = \frac{I_{C2}}{C_2}; \quad \frac{U_{C2}}{R_2} = I_{R2};$$

$$\frac{dU_{C3}}{dt} = \frac{I_{C3}}{C_3}; \quad U_{C2} = U_{C3} + I_{C3}R_3;$$

$$U_{C01} = U_{C2} + I_{R2}R_2 = U_{C2} + (I_{C2} + I_{R4} + I_{C3})R_2;$$

$$I_0 = I_{C01} + I_{R01} + I_{C2} + I_{R4} + I_{C3}, \quad (4.1)$$

where

U_{C01} – EMC temperature, K;

I_{C01} – EMC heat flow, W;

I_{R01} – EMC and sorbent tank heat flow, W;

U_{C2} – temperature of detector holder, K;

I_{C2} – heat flow of detector holder, W;

I_{C3} – detector heat flow, W;

U_{C3} – detector temperature, K;

I_{R4} – heat flow from detector cap to detector holder, W.

During the transformations from the equation system (4.1), the third-generation linear differential equations that describe the cooling process of each cryostat component were obtained. For example, Equation (4.2) describing the cooling process of the detector holder:

$$a_3 \frac{d^3 U_{C2}}{dt^3} + a_2 \frac{d^2 U_{C2}}{dt^2} + a_1 \frac{dU_{C2}}{dt} + a_0 U_{C2} = I_0, \quad (4.2)$$

where

$$a_3 = C_{01} C_2 C_3 R_2 R_3; \quad (4.2.1)$$

$$a_2 = C_{01} \left[R_2 (C_2 + C_3) + C_3 R_3 \frac{R_2 + R_4}{R_4} \right] + C_2 C_3 R_3 \frac{R_2}{R_{01}} + C_2 C_3 R_3; \quad (4.2.2)$$

$$a_1 = C_{01} \frac{R_2 + R_4}{R_4} + C_2 \frac{R_2}{R_{01}} + C_3 \frac{(R_{01} + R_2)(R_3 + R_4) + R_3 R_4}{R_{01} R_4}; \quad (4.2.3)$$

$$a_0 = \frac{R_{01} + R_2 + R_4}{R_{01} R_4}. \quad (4.2.4)$$

The current temperature of the cryostat components in the cooling process:

$$U_{Ci}(t) = U_{Ci}(0) - (U_{Cist} + A_{i,1} e^{p_1 t} + A_{i,2} e^{p_2 t} + A_{i,3} e^{p_3 t}), \quad (4.3)$$

where

$U_{Ci}(0)$ – initial temperature in i -component before cooling;

U_{Cist} – steady-state temperature in i -th component after cooling;

$A_{i,j}$ – coefficients of the i -component cooling transition process;

p_1 ; p_2 ; p_3 – the roots of the characteristic equation of the transition process;

$$A_{i,1} = \frac{U_i''(0) - U_i'(0)(p_3 + p_2) + (U_i(0) - U_{Cist})p_2 p_3}{(p_3 - p_1)(p_2 - p_1)}; \quad (4.4)$$

$$A_{i,2} = \frac{-U_i''(0) + U_i'(0)(p_3 + p_1) - (U_i(0) - U_{Cist})p_1 p_3}{(p_3 - p_{21})(p_2 - p_1)}; \quad (4.5)$$

$$A_{i,3} = \frac{U_i''(0) - U_i'(0)(p_2 + p_1) + (U_i(0) - U_{Cist})p_1 p_2}{(p_3 - p_{21})(p_3 - p_1)}. \quad (4.6)$$

The proposed model was used for the analysis of an existing gamma spectrometer, for calculating the cooling process of an HPGe detector and verified by experimentation (Fig. 4.4). The transition process under consideration is represented as the sum of three exponential functions with time constants (4.7)–(4.9):

$$\tau_1 = -\frac{1}{p_1} = 3.4 \text{ min}; \quad (4.7)$$

$$\tau_2 = -\frac{1}{p_2} = 21.8 \text{ min}; \quad (4.8)$$

$$\tau_3 = -\frac{1}{p_3} = 3.3 \text{ hours}. \quad (4.9)$$

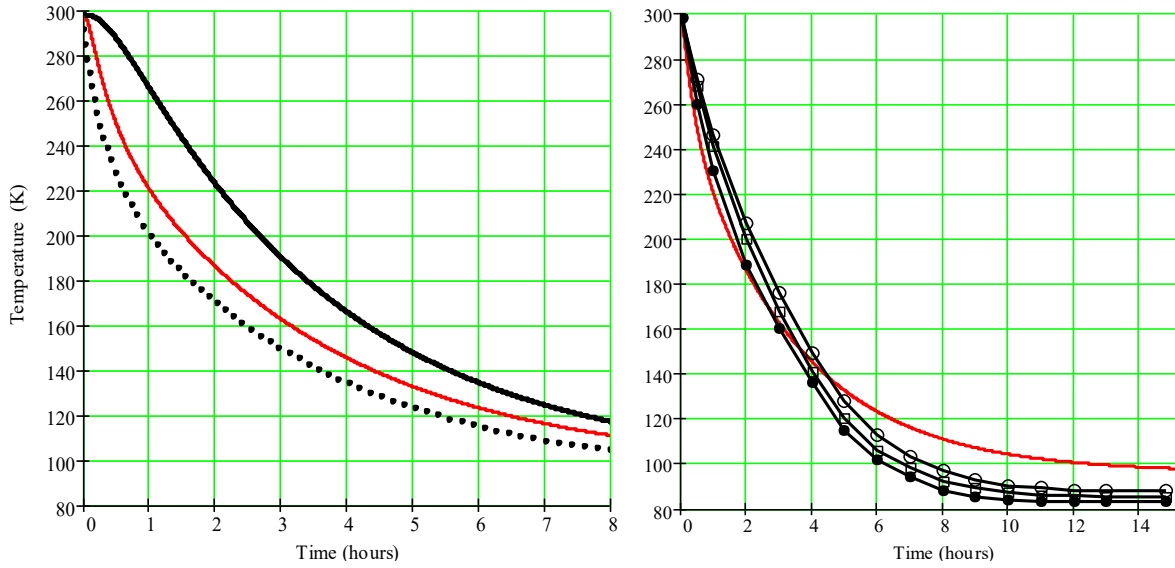

Fig. 4.4. Detector (black curve), detector holder (red curve), sorbent tank (dotted line) calculated cooling curves (left side); experimental (black curves) and calculated (red curves), comparison (right side).

For thermal shield (Fig. 4.5) efficiency calculation cryostat heat flow was analyzed. In general, the equilibrium equation is as follows:

$$Q_{23} + Q_{3\text{cond}} = Q_{31} \quad (4.10)$$

where

$$Q_{23} = Q_{23\text{rad}} + Q_{23\text{resid}}, Q_{31} = Q_{31\text{rad}} + Q_{31\text{resid}} \quad (4.11)$$

where

$Q_{3\text{cond}}$ – heat transfer to the thermal shield from the outer cover support due to thermal conductivity;

$Q_{23\text{rad}}$ – heat transfer to the thermal shield due to the thermal radiation of the outer cap;

$Q_{23\text{resid}}$ – heat transfer to the thermal shield from the outer cap due to the thermal conductivity of residual gases in the cryostat;

$Q_{31\text{rad}}$ – heat transfer to the detector due to thermal radiation of the thermal shield;

$Q_{31\text{resid}}$ – heat transfer to the detector from the thermal shield due molecular conductivity of residual gases in cryostat.

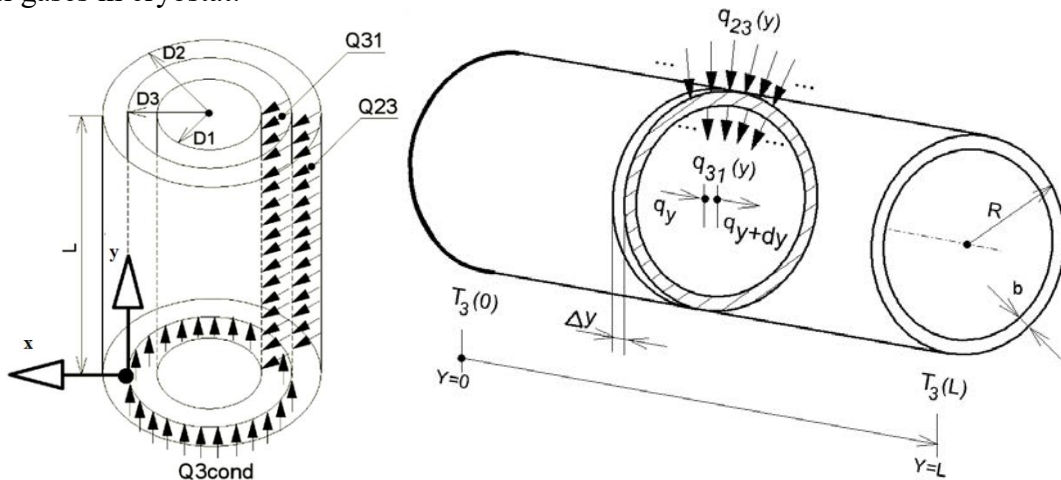

Fig. 4.5. Heat shield calculation model in cryostat (left); energy balance for infinitely small element (right).

Considering energy balance

$$q_y + \Delta q_c = q_{y+\Delta y}, \quad (4.12)$$

where

$$\Delta q_c = \Delta q_{23\text{rad}} - \Delta q_{13\text{rad}} + \Delta q_{23\text{resid}} - \Delta q_{13\text{resid}}. \quad (4.13)$$

By dividing the equation Δy and by executing the boundary, if $\Delta y \rightarrow 0$:

$$-\frac{dq_y}{dy} - \frac{dq_c}{dy} = 0, \quad (4.14)$$

where

$$\begin{aligned} dq_c = & \varepsilon_{23} \cdot \sigma \cdot dS_{y,3}(T_2^4 - T^4) - \varepsilon_{13} \cdot \sigma \cdot dS_{y,1}(T^4 - T_1^4) \\ & + \alpha_{23} \cdot B \cdot p \cdot dS_{y,3}(T_2 - T) - \alpha_{13} \cdot B \cdot p \cdot dS_{y,1}(T - T_1), \end{aligned} \quad (4.15)$$

$$\frac{dS_{y,3}}{dy} = P_3 = \pi D_3; \quad (4.16)$$

$$\frac{dS_{y,1}}{dy} = P_1 = \pi D_1. \quad (4.17)$$

According to Fourier law, the differential Equation (4.14) has the following type:

$$\frac{d}{dy} \left[k(y)A(y) \frac{dT}{dy} \right] - \frac{dq_c}{dy} = 0. \quad (4.18.)$$

If the area of the slice of the heat shield is constant throughout its length, Equation (4.18) becomes the second order differential equation with constant coefficients:

$$k \cdot A \frac{d^2 T}{dy^2} - \frac{dq_c}{dy} = 0, \quad (4.19)$$

where

$$A = b \cdot P_3 \left(1 - \frac{b}{D_3} \right) = b \cdot \pi \cdot D_3 \left(1 - \frac{b}{D_3} \right). \quad (4.20)$$

By inserting (4.15) in (4.19), a differential equation for changing the surface temperature of the heat shield was obtained (4.21).

$$\begin{aligned} \frac{d^2 T}{dy^2} - \frac{\varepsilon_{23} \cdot \sigma}{k \cdot b \left(1 - \frac{b}{D_3} \right)} (T_2^4 - T^4) + \frac{\varepsilon_{13} \cdot \sigma}{k \cdot b \left(1 - \frac{b}{D_3} \right)} \cdot \frac{D_1}{D_3} (T^4 - T_1^4) \\ - \frac{\alpha_{23} \cdot B \cdot p}{k \cdot b \cdot \left(1 - \frac{b}{D_3} \right)} (T_2 - T) + \frac{\alpha_{13} \cdot B \cdot p}{k \cdot b \cdot \left(1 - \frac{b}{D_3} \right)} \cdot \frac{D_1}{D_3} (T - T_1) = 0 \end{aligned} \quad (4.21)$$

where

$$\varepsilon_{23} = \frac{1}{\frac{1}{\varepsilon_{sh2}} + \left(\frac{1}{\varepsilon_2} - 1 \right) \frac{D_3}{D_2}}; \quad (4.22)$$

$$\varepsilon_{13} = \frac{1}{\frac{1}{\varepsilon_1} + \left(\frac{1}{\varepsilon_{sh1}} - 1 \right) \frac{D_1}{D_3}}. \quad (4.23)$$

The boundary conditions of the resulting differential equation solution are as follows:

$$T_{y=0} = T_0; \quad (4.24)$$

$$\frac{dT_{y=L}}{dy} = 0. \quad (4.25)$$

Stabilized temperature set from (4.23) provided

$$\frac{d^2T}{dy^2} = 0 \quad \left(\text{because } \frac{dq_c}{dy} = 0 \right). \quad (4.26)$$

Then the differential Equation (4.21) turns into an energy balance equation.

For the experimental research a cryostat with a thermal shield was developed and manufactured, which is equipped with temperature and pressure transducers (Fig. 4.6).

The heat model calculation model based on the hypotheses of the system of differential equations of classical mathematics was compiled and the temperature decomposition on the heat detector of the detector was calculated (Fig. 4.7). New results have been obtained on the effective reduction of heat flow to the detector by using a thermal shield (not only in the high but also in the average vacuum area) (Fig. 4.7–Fig. 4.12).

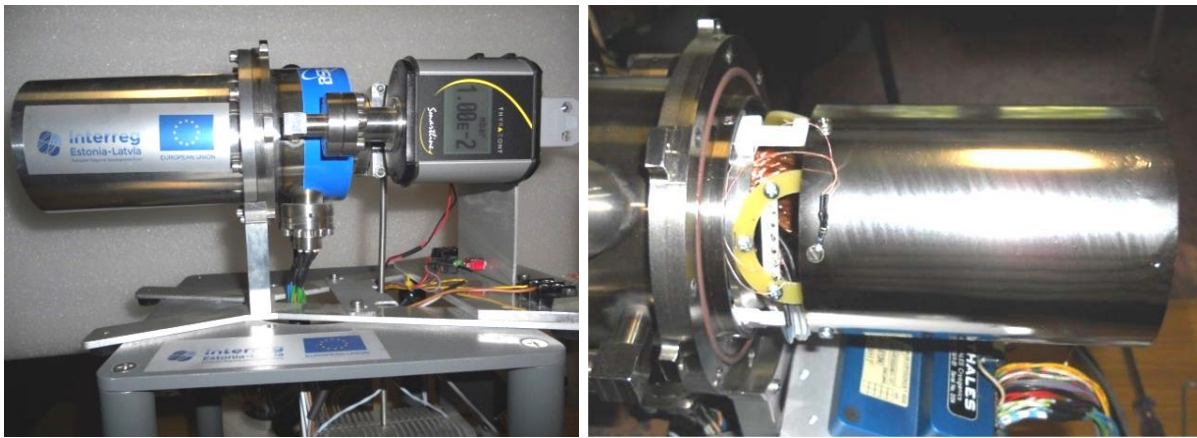

Fig. 4.6. Overview of cryostat for studies (left) and thermal shield in assembled form (right).

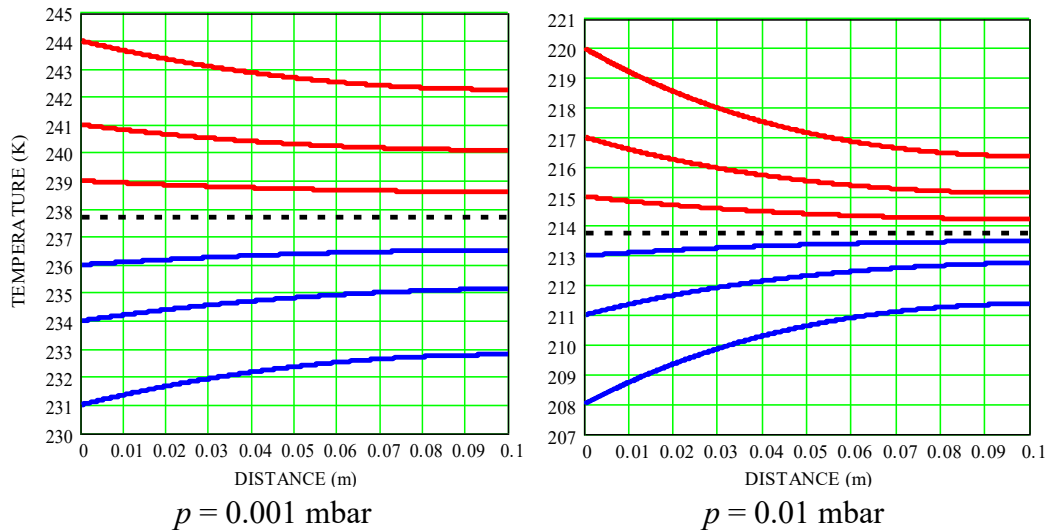

Fig. 4.7. Distribution of temperature on the surface of stainless-steel heat shield (0.5 mm thick) for various initial gas temperatures and pressures.

Based on the equations obtained, the support of the heat supply component was calculated for the cryostat due to $Q_{3\text{cond}}$ thermal conductivity, $Q_{32\text{rad}}$ and $Q_{31\text{rad}}$ heat radiation, as well as the molecular conductivity of the residual gases $Q_{32\text{resid}}$ and $Q_{31\text{resid}}$. The data in Table 4.2

allow to assess their relationship and to develop practical recommendations for the reduction of heat input into the cryostat. Table 4.3 shows the values of the thermal shield to the cooled detectors (with a thermal shield and without). Calculations show a decrease in heat input 2–3 times, and this ratio is maintained if the gas pressure in the cryostat changes within wide limits. The temperatures of the thermal shield, calculated on the basis of the energy balance equation (4.26), are marked with crosses in Fig. 4.11.

Table 4.2

Components of Heat Transfer in the Cryostat for Various Gas Pressures

Pressure, mbar	Thermal shield, K	Heat transfer to the thermal shield from the outer cap				Heat transfer to the detector from the thermal shield		
		$Q_{3\text{cond}}$, W	$Q_{32\text{rad}}$, W	$Q_{32\text{resid}}$, W	Q_{32_total} , W	$Q_{31\text{rad}}$, W	$Q_{31\text{resid}}$, W	Q_{31_total} , W
0.0001	252.32	0.053	0.332	0.009	0.394	0.367	0.027	0.394
0.001	242.36	0.066	0.389	0.114	0.569	0.312	0.257	0.569
0.01	215.94	0.099	0.509	1.707	2.315	0.194	2.121	2.315
0.02	211.09	0.105	0.527	3.623	4.255	0.177	4.078	4.255

Table 4.3

Thermal Shield Effectivity in Cryostat for Various Gas Pressures

Pressure, mbar	Heat transfer to the detector from the thermal shield			Heat transfer to detector from external cap (without thermal shield)			Shield efficiency
	$Q_{31\text{rad}}$, W	$Q_{31\text{resid}}$, W	Q_{31_total} , W	$Q_{21\text{rad}}$, W	$Q_{21\text{resid}}$, W	Q_{21_total} , W	Q_{21}/Q_{31} , W
0.0001	0.367	0.027	0.394	1.146	0.035	1.181	2.99
0.001	0.312	0.257	0.569	1.146	0.348	1.494	2.63
0.01	0.194	2.121	2.315	1.146	3.481	4.627	2.00
0.02	0.177	4.078	4.255	1.146	6.961	8.107	1.91

In *Solidworks* (Fig. 4.8), an evaluation of the cryostat cooling process [11] was performed (Fig. 4.9) and verified with the experimental (Fig. 4.10) real cryostat cooling.

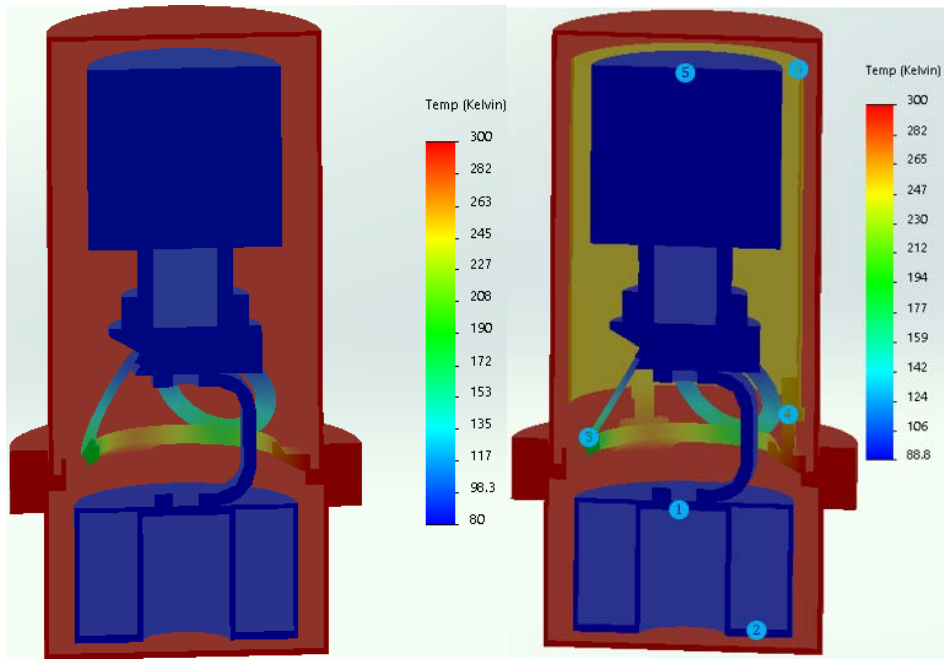

Fig. 4.8. The cryostat temperatures (without the thermal shield (left) and with the thermal shield (right)) have stabilized in the cooling state of *Solidworks*.

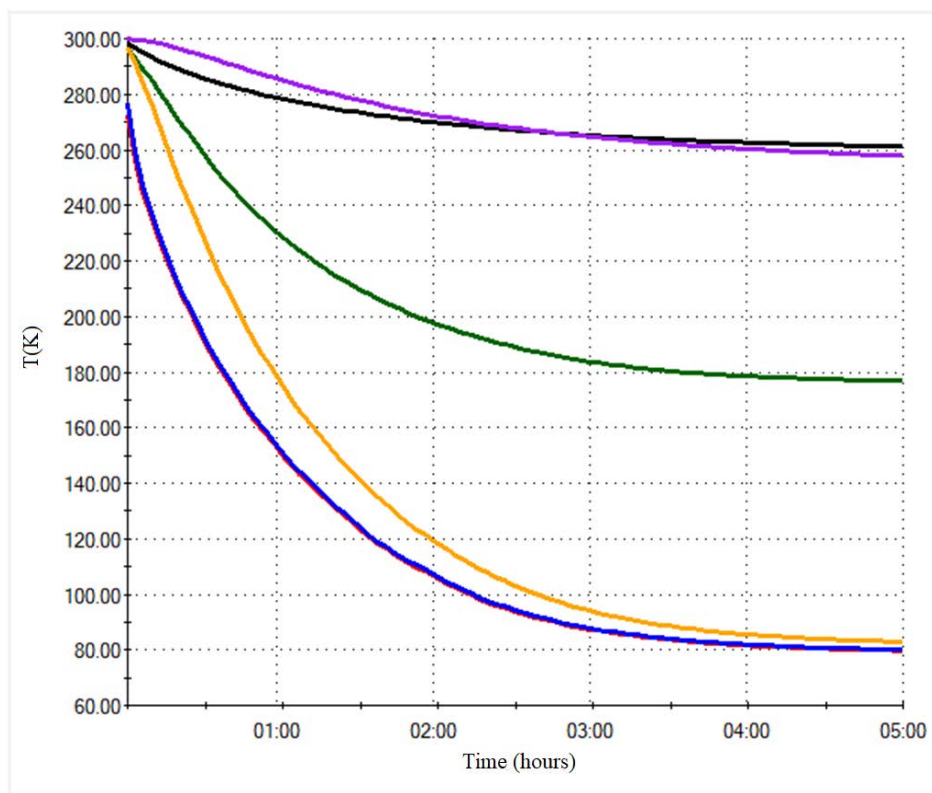

Fig. 4.9. Cooling curves for cryostat (Fig. 4.8.) components.

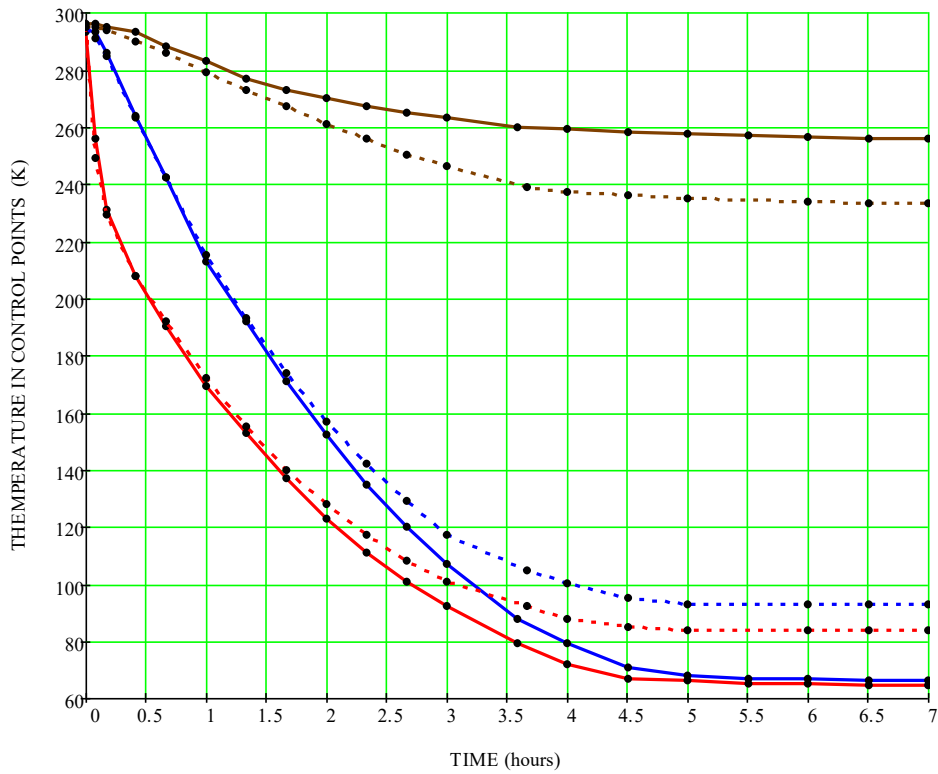

Fig. 4.10. Cryostat with thermal shield cooling curves (continuous lines: $p < 10^{-5}$ mbar; dotted line: $p = 4 \cdot 10^{-3}$ mbar). Red curves – temperature at the cold end of EMC; blue curve – temperature on HPGe detector holder; brown curve – temperature on the thermal shield.

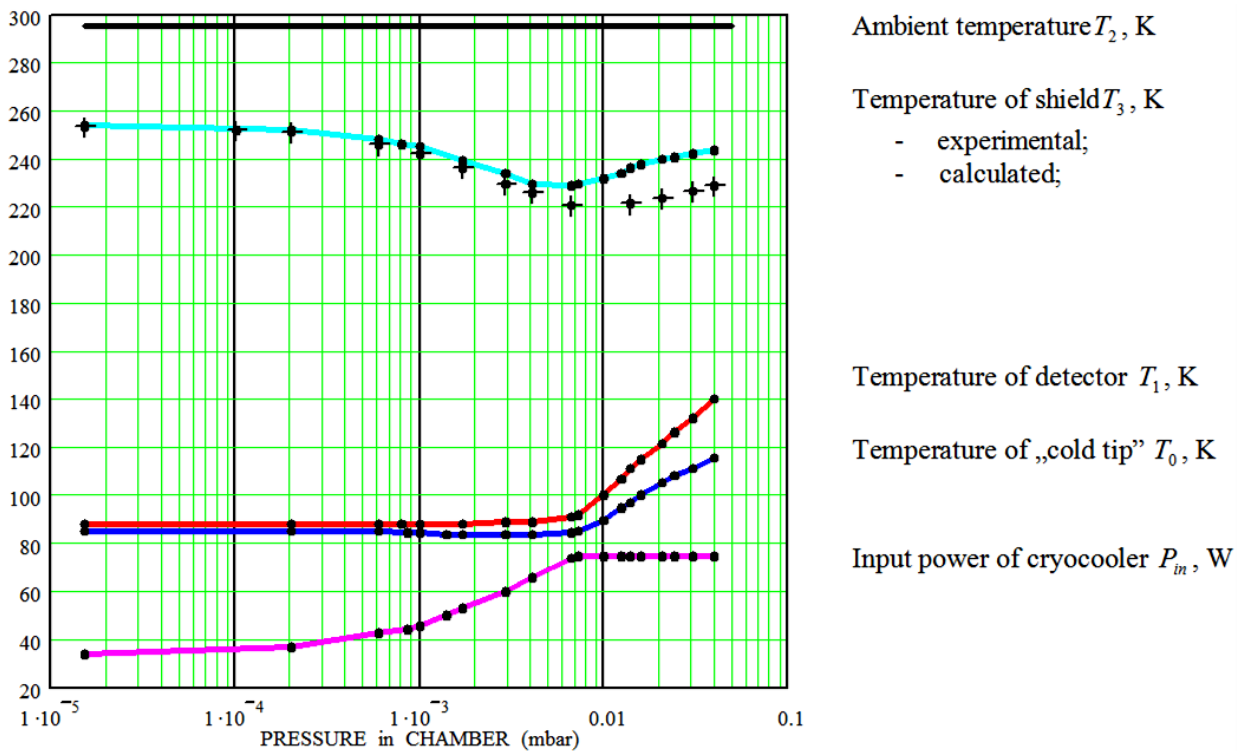

Fig. 4.11. Changing the temperature at the control points and changing the EMC input power at different pressures in a cryostat vacuum chamber.

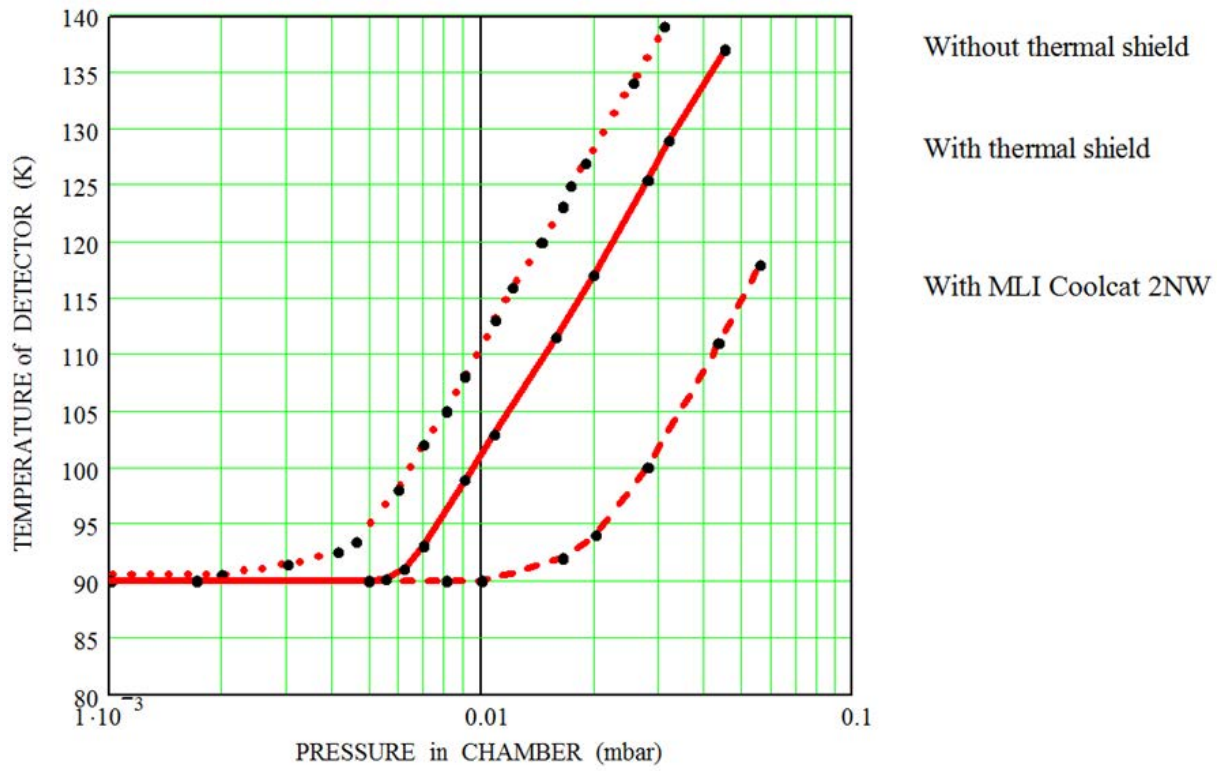

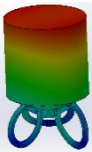
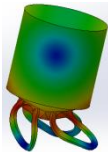

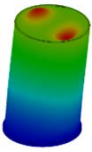
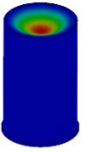
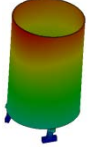
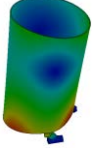

Fig. 4.12. The temperatures of detector for varied pressures in a vacuum chamber without thermal shield (dotted curve); with thermal shield (solid curve) and with MLI (dashed curve).

5. RESONANCE EVALUATION IN CRYOSTAT WITH EMC

In **Chapter 6**, a modal analysis of the detector unit and the detector cap was performed with the help of *Solidworks*. A passport for the cryostat oscillation system of the HPGe gamma spectrometer has been generated for the diagnosis of the microphone noise source (Table 5.1). Following the passport of the gamma spectrometer, it is possible to determine the source of the microphone effect on the basis of the spectrum analysis of the preamplifier output signal.

Table 5.1

Passport of HPGe Gamma Spectrometer Cryostat

		Bending mode	Bending mode	Torsional mode	Axial mode
Holder supports	Mode				
	Frequency	50 Hz	236 Hz	162 Hz	155 Hz
Detector cover	Mode				
	Frequency	2379 Hz			1076 Hz
Thermal shield (1 mm)	Mode				
	Frequency	161 Hz	643 Hz	264 Hz	735 Hz

Theoretical hypotheses about the reliability of the simulation results have been verified by experimental testing using the electrodynamic vibrating device *YBЭ-1-004* (Fig. 5.1). The amplitude-frequency curves of the oscillation amplitude of the detector holder supports were obtained (Fig. 5.3). Previous computer simulation was performed to evaluate the frequency range in which the search was to be carried out (Fig. 5.2). Figure 5.3. shows the results of the vibration acceleration measurements of the detector unit in the axial (vertical) and transverse (horizontal) directions that are triggered from the vibrating device *YBЭ-1-004*.



Fig. 5.1. Arrangement of accelerometers that measure the vibration accelerations of the detector unit on the ring supports from the *Composite G-Etronax* (left) and *CESTILENE HD 1000* (right) material.

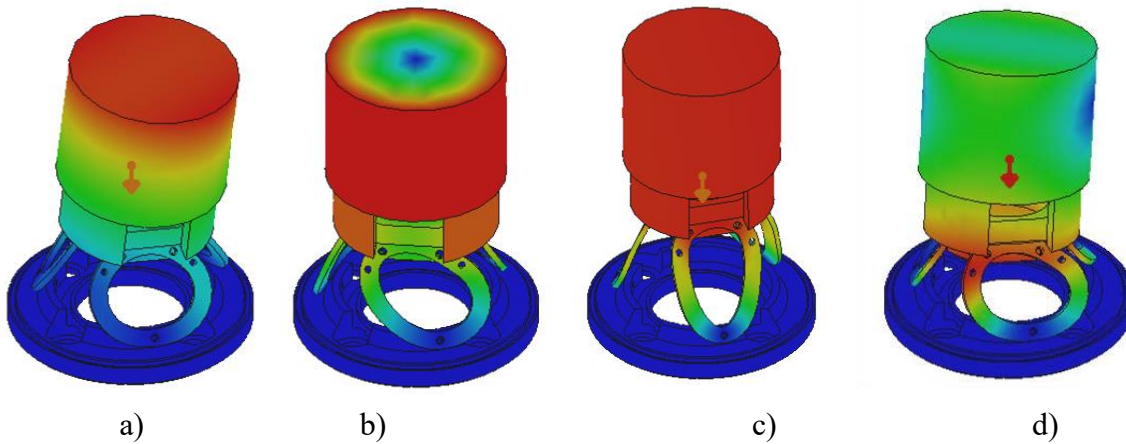

Fig. 5.2. Lower modes of detector unit: a) and d) bending; b) torsional; c) axial.

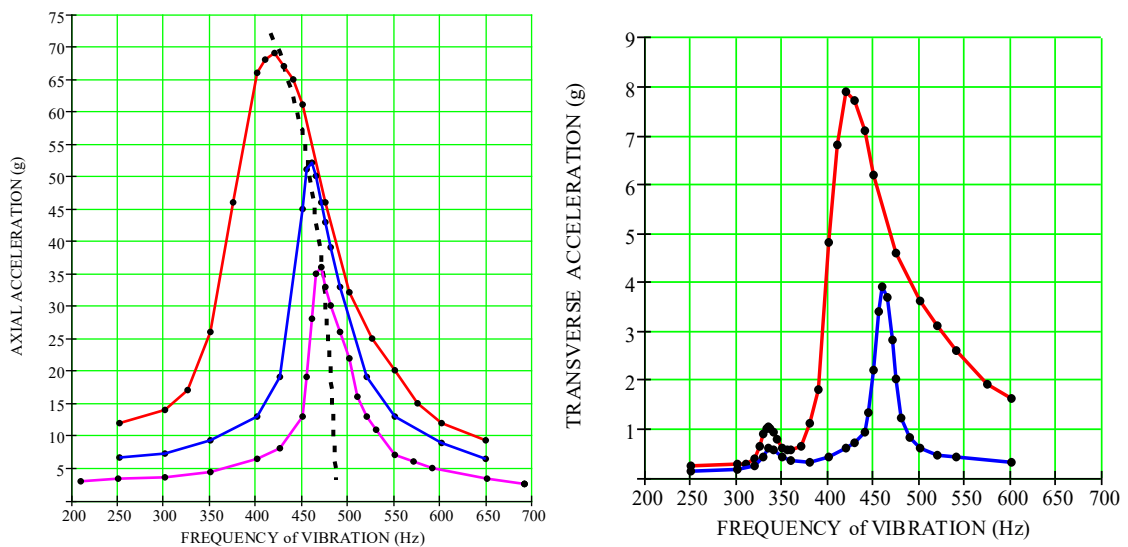

Fig. 5.3. Dependency of the vibration acceleration of the detector unit in the axial (vertical) (left) and transverse (horizontal) (right) direction of the frequency if there is a constant amplitude of the base vibration acceleration: 9g – red line; 4g – blue line; 2g – pink line.

An accelerometer *ZETLab BC110* (Fig. 5.4. a)) with a sensitivity of 100 mV/g was installed on the *Monolith* gamma spectrometer input window for experimental evaluation of the low-frequency fluctuation of the detector cover. When the EMC was turned off, the test hammer triggered a free cap with oscillations of the accelerometers installed (Fig. 5.4).

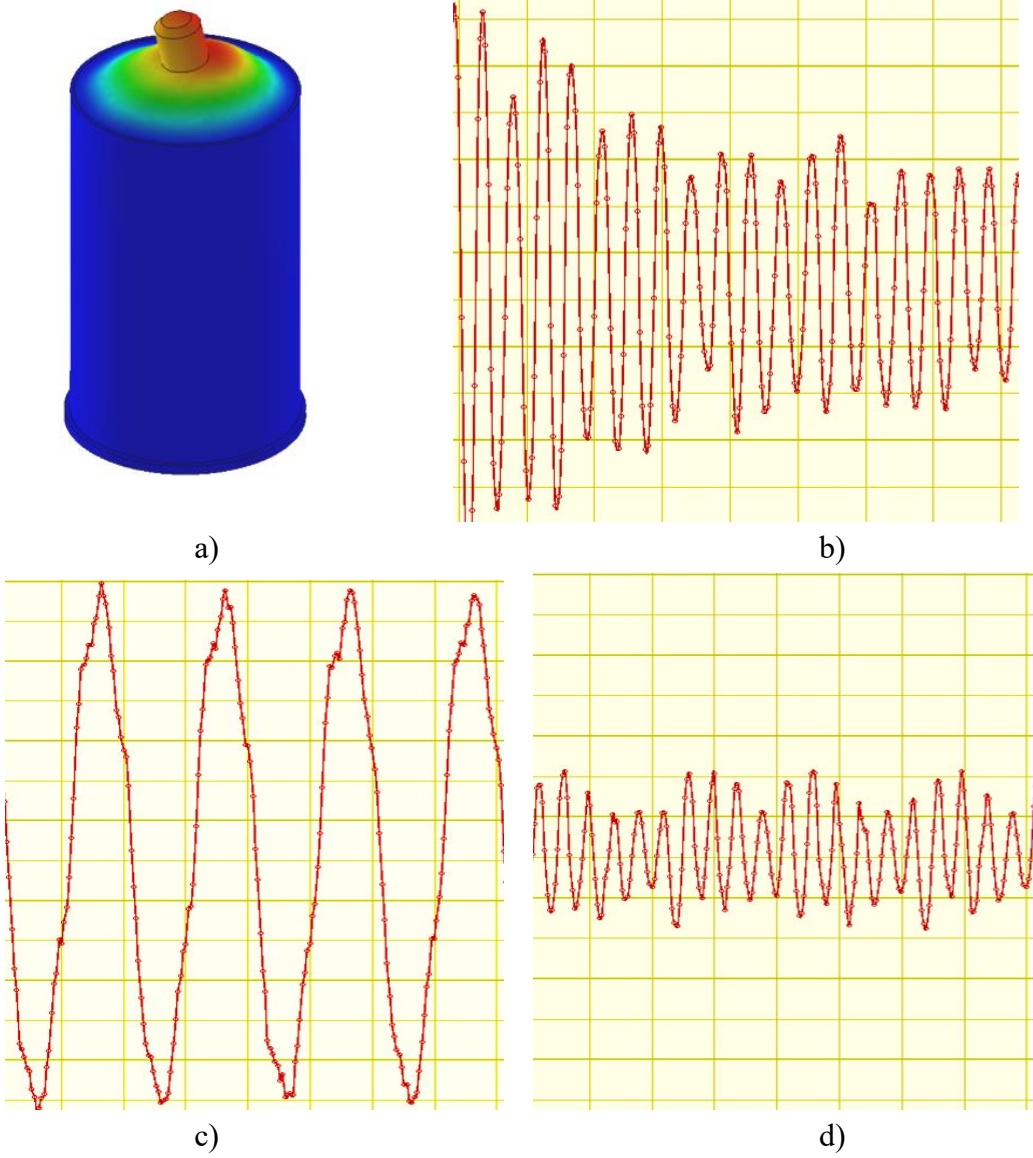

Fig. 5.4. Outer cap with accelerometer and vibration acceleration in axial direction (a): b) free oscillations after impact, frequency – 465 Hz; c) forced oscillations on the EMC housing; operating frequency – 100 Hz; d) forced oscillations on the input window. Scale at y axis: 0.05 g/div, at x axis: 5 ms/div

The experiment confirmed not only the accuracy of the computer model and its modal analysis, but also the practical excitation of the resonance oscillation of the outer cap. Vibrations are obtained with an installed accelerometer on the outer cap. Without the accelerometer, the oscillation modes are higher than the frequency range under consideration. To eliminate the effect on the accelerometer mass resonance frequency, the oscillation excitation was performed by the acoustic method. The lowest modes calculation of the outer cap with a fixed accelerometer on its input window surface with *Solidworks* is close to the analytically calculated value.

6. APPROBATION OF RESULTS

The approbation and practical applications of the results are described in **Chapter 7**. Existing and newly updated cryostats of electromagnetic coolers (EMC) were developed in *Solidworks* (Fig. 6.1.).

Practical results obtained during the work were used by *Baltic Scientific Instruments* company in developing and producing gamma spectrometers for various types of applications. The act on the implementation of the completed scientific research work in the production process of the *Baltic Scientific Instruments* company is approved as a confirmation of the implementation of the recommendations of the development of the HPGe gamma spectrometers obtained within the framework of the work.

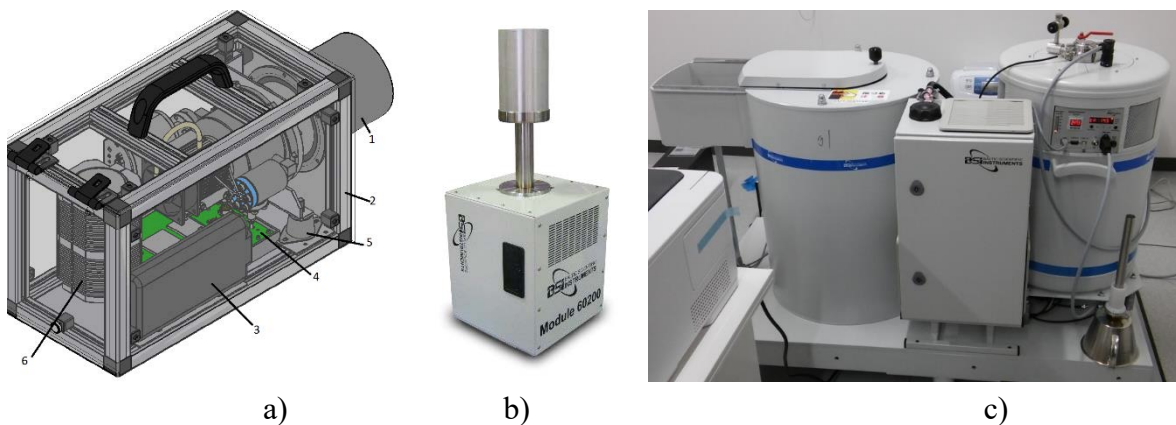

Fig. 6.1. a) portable gamma spectrometer *HandSPEC*; b) *Monolith* laboratory gamma spectrometer; c) *Nicole* gamma spectrometer with hybrid cooling.

7. CONCLUSIONS

Chapter 1 of the Thesis analyzes, researches and evaluates scientific equipment with high purity germanium (HPGe) detectors. The unique possibilities of modern gamma spectrometry for various research areas are described. Descriptions of the possibilities for developing HPGe gamma spectrometers using EMC as an HPGe detector cooler are presented. Their advantages are described, such as reducing gamma spectrometer gauge and weight, comfort and safety in use, the ability to install the device in a human-dangerous environment without the need for maintenance and work in any spatial condition. The topicality of the task in the context of dynamic process research in critique with EMC and search for typical mitigation techniques is described.

Chapters 2 and 3 of the Thesis deals with the analysis of thermal processes and mechanical vibrations in dynamic processes in the cryostat of gamma spectrometers with an electromachine cooler (EMC). Physical processes of standard construction with EMC-cooled cryostat are considered. The focus is on EMC-specific processes based on dynamic heat and mechanical models. It has been shown that EMC operation with reduced power reduces its vibroactivity by more than 40 %. Critostat with HPGe detector and main oscillation systems of EMC typical design whose mechanical oscillations cause a microphone effect that significantly reduces the gamma spectrometer's energy resolution are analyzed. Parameter string of highly certified germanium detectors is used in gamma spectrometers with electromachine coolers, which adds an additional task of developing HPGe detector holder unified node. Opportunities are analyzed and recommendations proposed for reducing the negative effects of EMC vibrations.

Chapter 4 develops and describes a technical task in the form of a block diagram for a complex approach to constructing gamma spectrometer cryostats with EMC. The results of the acquired dynamic thermal and vibration model study formulated the necessary operations by constructing the cryostat of the HPGe spectrometer using EMC. Within the framework of the Thesis, practical recommendations were proposed that allow to reduce the impact of typical deficiencies of EMC.

In **Chapter 5**, the methodology was developed, modeling calculations were done with *MathCAD* and *Solidworks* computer programs as well as experiments on heat process modeling in cryostats with electromachine cooler (EMC). The dynamic heat model of cryostat with electromachine coolers and heat shields has been developed, which is made with the help of thermoelectric analogy hypothesis. The model described by the system of nonlinear differential equations is solved, analyzed and optimized. Results are obtained that describe the temperature distribution on the surface of the screen. This allows to determine the effect of heat supply and control depending on the conductivity of the molecular residue gas cryostat. New results have been obtained on the effective reduction of heat flow to the detector using a heat sink (not only in the high but also in the average vacuum area). Calculations show a decrease in heat supply 2–3 times, and this ratio is maintained if the gas pressure in the cryostat changes within wide limits. In *Solidworks* an evaluation of the cryostat transition

cooling process was performed and verified by experimentally obtained real cryostat during cooling.

In **Chapter 6**, a modal analysis of the gamma spectrometer cryostat oscillation basic systems was performed with the help of *Solidworks* program's fundamental hypothesis. Theoretical hypotheses about the reliability of the simulation results have been verified by experimental testing using an electrodynamic vibrating device *VBЭ-1-004*. The results of the computer simulation showed that the modal analysis can be used to estimate the frequency characteristics of the gamma spectrometers to be developed, as well as to determine the resonance modes. A modal analysis of the cryostat oscillation basic passport of a gamma spectrometer that makes it possible to identify the source of a microphone based on a spectrum analysis of the preamplifier output signal.

Chapter 7 of the Thesis describes the new cryostats of electromachine coolers (EMC) developed for the existing and developed in *Solidworks* environments. Practical results obtained during the work were used by *Baltic Scientific Instruments* company to develop and produce new spectrometers for various applications. The act on the implementation of the completed scientific research work in the production process of the *Baltic Scientific Instruments* company is approved as a confirmation of the implementation of the recommendations of the development of the HPGe gamma spectrometers obtained within the framework of the Thesis.

THE BIBLIOGRAPHY

- [1] G. F. Knoll, *Radiation Detection and Measurement*, 3rd ed. New York, 2000.
- [2] S. T. Werrett, G. D. Peskett, G. Davey, T. W. Bradshaw, and J. Delderfield, “DEVELOPMENT OF A SMALL STIRLING CYCLE COOLER FOR SPACEFLIGHT APPLICATIONS”, in *Advances in Cryogenic Engineering*, 1986.
- [3] A. Veprik, Sf. Zehtzer, N. Pundak, and S. Riabzev, “Compact Linear Split Stirling Cryogenic Cooler for High Temperature Infrared Imagers,” *Cryocoolers*, vol. 16, pp. 121–132, 2011.
- [4] A. Veprik, S. Riabzev, N. Avishay, D. Oster, and A. Tuitto, “Linear cryogenic coolers for HOT infrared detectors,” p. 83531V–83531V–11, 2012.
- [5] D. L. Johnson, I. M. Mckinley, J. I. Rodriguez, H. Tseng, and B. A. Carroll, “Characterization Testing of the Thales LPT9310 Pulse Tube Cooler,” pp. 116–124, 2014.
- [6] D. L. Johnson, J. I. Rodriguez, B. A. Carroll, J. G. Bustamante, and C. S. Kirkconnell, “Integrated Testing of the Thales LPT9510 Pulse Tube Cooler and the Iris LCCE Electronics,” 2013.
- [7] T. Namba, Y. Inoue, S. Moriyama, and M. Minowa, “An X-ray detector using PIN photodiodes for the axion helioscope,” *Nucl. Instruments Methods Phys. Res. Sect. A Accel. Spectrometers, Detect. Assoc. Equip.*, 2002.
- [8] R. M. Keyser, R. D. Bingham, and T. R. Twomey, “Improved performance in germanium detector gamma-spectrometers based on digital signal processing,” *J. Radioanal. Nucl. Chem.*, 2008.
- [9] I. Kojouharov, J. Gerl, M. Steinen, A. Sanchez-Lorente, J. Pochodzalla, and J. Kojouharova, “Optimization of electrically cooled complex HPGe detector,” *Proc. - UKSim-AMSS 6th Eur. Model. Symp. EMS 2012*, no. 4500109716, pp. 461–465, 2012.
- [10] O. Jakovļevs, V. Malgin, and J. Vība, “Modal analysis of HPGe detector assembly in gamma-ray spectrometers,” vol. 1, pp. 61–66, 2017.
- [11] M. Wolf et al., “Temperature Distribution Study of Composite Germanium Detector,” pp. 2–5.