



RIGA TECHNICAL  
UNIVERSITY

**Miķelis Dzikēvičs**

# **SOLAR ENERGY ACCUMULATION WITH PACKED BED PHASE CHANGE MATERIALS**

Summary of the Doctoral Thesis



RTU Press  
Riga 2019

**RIGA TECHNICAL UNIVERSITY**

Faculty of Power and Electrical Engineering

Institute of Energy Systems and Environment

**Miķelis Dzikēvičs**

Doctoral Student of the Study Programme “Environmental Science”

**SOLAR ENERGY ACCUMULATION WITH  
PACKED BED PHASE CHANGE MATERIALS**

**Summary of the Doctoral Thesis**

Scientific supervisor  
Professor Dr. habil. sc. ing.  
**IVARS VEIDENBERGS**

RTU Press  
Riga 2019

Dzikēvičs, M. Solar Energy Accumulation With Packed Bed Phase Change Materials. Summary of the Doctoral Thesis. Riga: RTU Press, 2019. 21 p.

Published in accordance with the decision of the Promotion Council “RTU P-19” of June 17, 2019, Minutes No. 106.

I would like to express my gratitude to people and to aspects of my life that led me to write this Thesis – firstly my parents for providing my childhood in countryside where environment allowed me to experiment with nature and work with different tools in father’s garage starting from very basic woodworking and metalworking to building primitive electronics – mostly for our toys.

Secondly, I think the existence of RTU and Institute of Energy Systems and Environment, headed by Dagnija Blumberga and all other personnel including my supervisor Ivars Veidenbergs, led me to a path of learning of and enjoying experimental method as a way of thinking. A crucial step in this development was being employed in the laboratory managed by Aivars Žandeckis and a possibility to work with long-time colleague Vladimirs Kirsanovs whose continuous progress is a great drive to continue my own development.

But none of this would have mattered if there was not someone to share the stride for better world in everyday life as well as in personal outer and inner growth, which is why I am eternally grateful to my partner in life Linda Lagzdīņa for helping to make all the right and wrong decisions in our lives that make me who I am.

**ISBN 978-9934-22-390-7 (print)**

**978-9934-22-391-4 (pdf)**

# **DOCTORAL THESIS PROPOSED TO RIGA TECHNICAL UNIVERSITY FOR THE PROMOTION TO THE SCIENTIFIC DEGREE OF DOCTOR OF ENGINEERING SCIENCES**

To be granted the scientific degree of Doctor of Engineering Sciences, the present Doctoral Thesis has been submitted for the defence at the open meeting of RTU Promotion Council on December 12, 2019 at the Faculty of Power and Electrical Engineering of Riga Technical University, Azenes Street 12/1, Room 116.

## **OFFICIAL REVIEWERS**

Professor Dr. sc. ing. Gatis Bažbauers  
Riga Technical University, Latvia

Professor Dr. sc. techn. Peter D. Lund  
Aalto University, Finland

Professor Dr. sc. ing. Ainis Lagzdiņš  
Latvia University of Life Sciences and Technologies, Latvia

## **DECLARATION OF ACADEMIC INTEGRITY**

I hereby declare that the Doctoral Thesis submitted for the review to Riga Technical University for the promotion to the scientific degree of Doctor of Engineering Sciences is my own. I confirm that this Doctoral Thesis had not been submitted to any other university for the promotion to a scientific degree.

Miķelis Dzikēvičs ..... (signature)

Date: .....

The Doctoral Thesis has been written in English. It consists of an introduction; 6 chapters; conclusion; 101 figures; 21 tables; 3 appendices; the total number of pages is 141, not including appendices. The bibliography contains 131 titles.

# CONTENTS

INTRODUCTION.....	5
1. EXISTING RESEARCH IN USE OF PCM IN THERMAL STORAGE .....	10
2. EXPERIMENTAL RESEARCH AND VALIDATION.....	12
3. ANNUAL MODEL RESULTS FOR SENSITIVITY, OPTIMIZATION AND USE OF MULTIPLE PCM .....	15
GENERAL CONCLUSIONS .....	19
REFERENCES.....	20

# INTRODUCTION

## Formulation of the Problem

In Europe, 64 % of energy consumption in households is used for space heating and preparation of hot water (Eurostat, 2018). In Latvia and other northern countries, heating needs have a seasonal nature which traditionally has been provided by using large thermal and cogeneration plants for base load and smaller systems for peak loads. To combat climate change, a transition from fossil fuels has mainly gone in the direction of using more biomass. However, with increasing attention to emission problems, biomass is not seen as ideal RES. Meanwhile, the development of solar thermal (ST) market has been slowing down not only in Latvia but also in all of Europe (European Solar Thermal Industry Federation, 2017).

In northern parts of Europe, ST systems are usually built as combi systems that provide hot water and heating. Additionally, there is an auxiliary heat source for periods without solar radiation. The solar fraction – a share of thermal energy which is produced with solar energy from the total required heating energy, of such systems, is in the range of 15–30 %. Low solar fraction and lack of space have been the main limiting factors for installation of ST systems. Availability of high-density thermal storage has been noted as one of the requirements for broader market diffusion of ST technology. (Weiss & Biermayr, 2008)

Higher density can be obtained by using non-sensible heat storage mediums such as phase change materials (PCMs) in latent thermal energy storage (LTES) systems. LTES have been found to increase energy density by up to 4 times (Bourne & Novoselac, 2015). However, most of the studies have been on the small scale experimental systems that do not take into account variability of solar energy in annual time periods and there is no methodology for choosing a melting point, PCM/water ratios or any other aspects (Reddy, Mudgal, & Mallick, 2018). Therefore, the usefulness of PCM use in ST systems is not clear.

## Relevance of the Thesis

To reduce the emissions for the production of primary energy, Directive 2009/28/EC and following Directive 2018/2001 focuses on the promotion of the use of energy from renewable sources. In Latvia, in recent years the share of heat produced from RES has increased. RES comprises the use of firewood, wood residues, wood chips, pellets and briquettes and straw (Fig. 1).

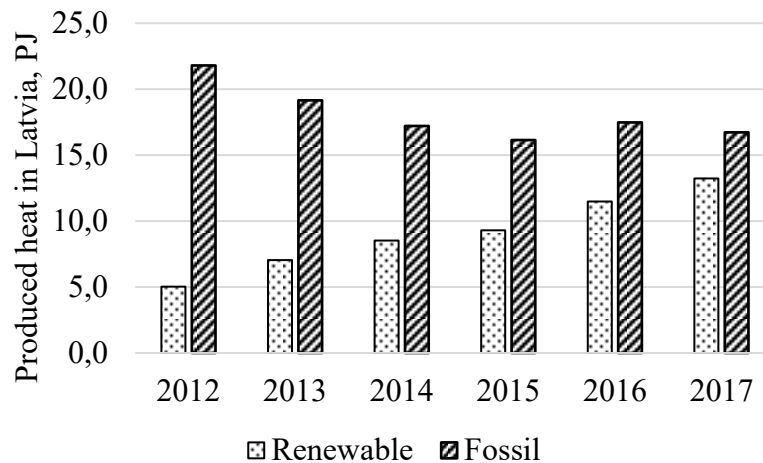

Fig. 1. Heat produced in Latvia from renewable and fossil fuels (Central Statistical Bureau of Latvia, 2019).

Burning these RES fuels result in air emissions. This is where Latvia's stride for more use of local RES encounters new problems, mainly in the form of solid particle matter (PM) emissions from burning biomass, which was not a problem with the use of natural gas, which has led to new Directives – 2015/1189, 2016/2284 and others, to combat emissions. PM emissions are a problem for Latvia, and it faces possible fines from the European Commission. Poor air quality places Latvia as the 3rd highest in the number of healthy years lost due to air pollution in Europe. (Niemenmaa et al., 2018)

To tackle these issues cleaner form of RES, such as solar energy, can be used. Limiting factors for ST installations include low prices of fossil fuels, lack of skilled human resources, political awareness, and the main factor is the availability of space and connecting factor of availability of key components like thermal storage with high energy density. (Weiss & Biermayr, 2008)

The global ST energy has a significant contribution in reducing global greenhouse gas emissions. Global ST yield in 2018 corresponded to savings of 42.6 million tons of oil and 137.5 million tons of CO<sub>2</sub>. Until 2015, ST was the leading RES technology in terms of cumulated installed capacity in operation, when it was overtaken by wind and in 2018 by PV. That and the fact that the global growth rate of ST market has been decreasing indicates that the new technology could help to continue the growth of technologies that provide energy and avoid CO<sub>2</sub> emissions during operation. (Weiss & Spork-Dur, 2019)

## The Object of Research

The object of research is a thermodynamic system of thermal storage with phase change materials.

## **The Aim of the Thesis**

The aim of the Thesis is to evaluate the application of PCMs in thermal storage in order to increase solar fraction and solar collector efficiency.

## **The Tasks of the Thesis**

In order to achieve the aim of the Thesis, the following objectives were set:

1. To carry out research analysis on solar thermal collector systems and phase change materials in order to design experimental set-up to be built within the laboratory and lead the installation of the system.
2. To carry out research analysis and experiments in order to obtain data for mathematical model validation.
3. To develop a short-term simulation model for a thermal energy storage tank and validate it with the obtained experimental data.
4. To develop a long-term simulation model of solar domestic heating system and evaluate PCM use in a domestic solar thermal system with thermal storage.

## **The Research Methods**

In the Thesis, the following analytical applied research methods were used: literature analysis, experimental analysis, thermodynamic analysis, sensitivity analysis and optimization analysis. The COMSOL and TRNSYS software were used for simulations.

## **Scientific Novelty of the Thesis**

The findings within the Thesis have provided new information within the field of energy storage about application of PCM within domestic solar thermal systems. The novel concept of stratified PCM use in thermal storage has been developed and evaluated in real system settings.

## **Practical Value of the Research Findings**

PCM use within thermal storage has been one of the most promising ways to increase energy density and remove limiting factors that slow the increase of solar thermal systems and their solar fraction. Variability of solar energy adds an uncertainty of usefulness of PCM use due to their working principle – PCM material must change phase to provide benefits over sensible heat systems. In combination of other possible variables in system design, research was necessary to advance closer to bringing LTES to the market.

The testing facility designed and built within the Thesis provides a possibility to test new designs and obtain much needed experimental data for validating mathematical models. The complexity of fluid dynamics in combination with phase change increase uncertainty of



mathematical models, therefore, experimental validation is an important part of developing new designs, which this system will be able to provide in further research.

Most of the existing research consists of experimental small-scale set-ups and research in approaches in describing the physical processes. Within this Thesis, it was decided that experimental set-up needs to be real scale to ensure new scientific information. The system is built at a scale of domestic solar heating set-up for a small family house. This reduces the uncertainty from scaling up systems with complex heat transfer processes, therefore it provides a better platform for validating mathematical models.

Simulations are carried out both in the short term for validation purposes and in the long term (annual) to obtain results of PCM use in real case scenarios. PCM is still in a development phase, where thermophysical properties of materials are improved and investigated. Sensitivity analysis is carried out and the parameters that have the highest impact of solar fraction and solar collector efficiency are defined.

A method for finding the suitable melting point of PCM based on temperature frequency graph for specific cases was developed. This methodology can be used by manufacturers to determine more frequent temperatures in the tank and if there are enough temperature variations above and below the melting point to promote phase change. Additional methodology is provided for choosing suitable materials in contact and PCM density.

## **Approval of the Findings**

6 scientific articles have been published on the topic of the Thesis which are indexed in SCOPUS database:

- Jansone, D., Dzikevics, M., & Veidenbergs, I. (2018). Determination of thermophysical properties of phase change materials using T-history method. *Energy Procedia*, 147, 488–494. doi:10.1016/j.egypro.2018.07.057
- Dzikevics, M., Ansone, A., & Veidenbergs, I. (2017). Experimental investigation of flow rate impact on thermal accumulation system with PCM. *Energy Procedia*, 128, 386–392. doi:10.1016/j.egypro.2017.09.043
- Dzikevics, M., Kirsanovs, V., Blumberga, D., & Veidenbergs, I. (2017). Design of experimental investigation about the effects of flow rate and PCM placement on thermal accumulation. *Energy Procedia*, 113, 58–62. doi:10.1016/j.egypro.2017.04.014
- Dzikevics, M., Ansone, A., & Blumberga, D. (2016). Modelling of phase change in spheres for applications in solar thermal heat storage systems. *Energy Procedia*, 95, 112–118. doi:10.1016/j.egypro.2016.09.031
- Dzikevics, M., Blumberga, A., & Blumberga, D. (2015). Conceptual design of experimental solar heat accumulation system with phase change materials. *Agronomy Research*, 13(2), 477–484. ISSN 1406-894X.
- Dzikevics, M., & Zandeckis, A. (2015). Mathematical model of packed bed solar thermal energy storage simulation. *Energy Procedia*, 72, 95–102. doi:10.1016/j.egypro.2015.06.014

The results of the Thesis were presented in 6 conferences:

- International Scientific Conference on Environmental and Climate Technologies, CONECT, 2018, Riga, Latvia.
- International Scientific Conference on Environmental and Climate Technologies, CONECT, 2017, Riga, Latvia.
- International Scientific Conference on Environmental and Climate Technologies, CONECT, 2016, Riga, Latvia.
- International Conference on Biosystems Engineering, 2015, Tartu, Estonia.
- International Scientific Conference on Environmental and Climate Technologies, CONECT, 2015, Riga, Latvia.
- International Scientific Conference on Environmental and Climate Technologies, CONECT, 2014, Riga, Latvia.

# 1. EXISTING RESEARCH IN USE OF PCM IN THERMAL STORAGE

The potential to store more energy has led to increased research in latent thermal storage systems from around 100 publications in the year 2000 to around 1000 publications per year in 2017 (Calderón et al., 2019). Use of PCMs has been researched for different applications – in buildings for cooling and heating and to lower temperature fluctuations (Buttitta, Serale, & Cascone, 2015; Cabeza, Castell, Barreneche, De Gracia, & Fernández, 2011; Lin, Jia, Alva, & Fang, 2017) and help in thermal management of buildings, which is a focal topic in building sector (Albatayneh, Alterman, Page, & Moghtaderi, 2017), storage tanks (Buttitta et al., 2015), solar energy storage (Anson, Dzikevics, & Zandeckis, 2016), textile (Sarier & Onder, 2012), and others. Underlying all the applications have been the research of thermal properties of PCMs – to increase thermal conductivity, reduce the separation of phases, reduce supercooling and find materials with high latent heat of fusion (Barreneche, Navarro, Cabeza, & Fernández, 2015).

Within this Thesis, the packed bed system where capsulated PCM is used that is placed in the tank. Packed bed means that containers are not fixed in position. It is chosen with the intent that realizing packed bed is a simpler solution than fixing containers, especially if PCM could be used as a refurbishment of existing sensible heat thermal storage tanks. Capsulation can increase heat transfer between PCM and heat transfer fluid (HTF), increase mechanical stability, which ensures stable phase transition for longer lifetime and also increases compatibility between PCM and HTF. Core to shell ratio was found to be a parameter that can be optimized to produce a container that is strong enough for application but has maximum possible amount of PCM in it. Naturally, materials with higher thermal conductivity, such as metals, are good in relation to heat transfer, however, organic PCMs can also be combined with materials such as Silica, which exhibits high mechanical strength, high thermal conductivity and acts as a good diffusion barrier. (Salunkhe & Shembekar, 2012)

The cost of the PCMs has been a limiting factor for wider application. The pricing in the Thesis is obtained in procurement procedures during the development of the laboratory facility. The price of the PCM was found to be in the range from 3.2 EUR/kg up to 43 EUR/kg. The cost depends on the amount of order – minimum order of 1 t is required in most cases to obtain a price without increased cost; container type – slabs commonly used in refrigeration cost less while spheres and smaller size containers that are harder to manufacture cost more; material of container – HDPE is cheaper since it can be moulded while it has good compatibility with many PCMs it has poor thermal properties and relatively low strength means that thick walls are used. Metals are more expensive but provide better thermal and strength properties, however, they can also have problems with compatibility with corrosive PCMs.

In mathematical simulations to analyse thermodynamic processes in TES systems, two main approaches exist – computational fluid dynamics for specific property analysis and transient (dynamic) modelling for long term analysis. TRNSYS software is often used in simulations of TES and in some cases TES with PCM (Baldwin & Cruickshank, 2016;

Belmonte, Eguía, Molina, Almendros-Ibáñez, & Salgado, 2015; Drück & habil Müller-Steinhagen Pfaffenwaldring, 2006; Najafian, Haghigat, & Moreau, 2015; Terziotti, Sweet, & McLeskey, 2012), therefore it was chosen as the simulation tool for this Thesis.

Most of the literature deals with describing small scale systems to analyse specific processes of using PCM and there is no definitive answer if PCM can be used in SDHW system and provide improvements as reduced consumption of auxiliary heating and increased solar fraction. Therefore, that was set as the aim of this Thesis.

## 2. EXPERIMENTAL RESEARCH AND VALIDATION

The experimental system was designed by the author and built in the laboratory of Institute of Energy Systems and Environment, Riga Technical University, consisting of multiple solar collectors, hydraulic system, control and experimental storage tank. The hydraulic system has two ways of simulating loads – by use of cold water and of roof cooler. The part used in the experimental research is illustrated in Fig. 2.1. The main component is the experimental tank (ET) that has a volume of 353 litres and removable top lid for the possibility to insert PCM and heat exchangers (HEX). Temperature measurement system consists of sensors placed vertically in the tank to obtain temperature within the tank, temperature at inlet and outlet, room temperature and temperature in PCM container.

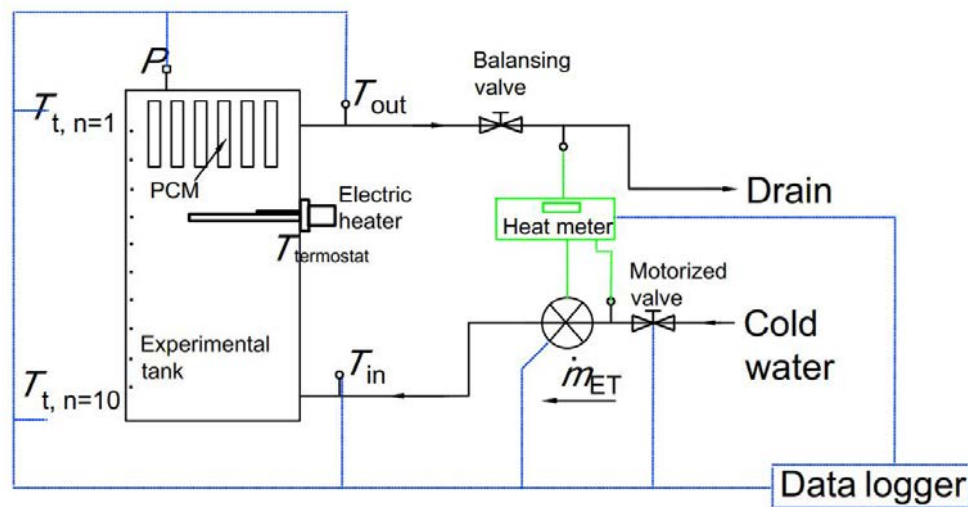

Fig. 2.1. Diagram for cooling experiments with cold water.

The PCM used in experimental research is organic, with latent heat value 210 kJ/kg, specific heat of 0.73 kJ/(kg·K), a melting point of 55 °C, density of 840 kg/m<sup>3</sup> and thermal conductivity of 0.2–0.3 W/(m·K). PCM comes in rectangular HDPE containers with a volume of 1.2 litres. 21 containers were placed in the top portion of the tank.

Charging and discharging experimental research was tested, however without stable heat source other than the electric heater in the tank, it was decided that discharge experiments provide more stable data and since the PCM which was used, had no supercooling, the cooling process of PCM follows the same hysteresis as the one in heating. During the experiments, the tank is heated to 65 °C and when all of the layers and PCM has reached that temperature, the cooling process is started in a direct method as in Fig. 2.1 with a flow rate of 600 L/h.

The main conclusions from experimental research were that, firstly, the speed with which PCM and water change temperature is similar, because water has higher thermal conductivity and specific heat, while PCM has lower thermal conductivity and lower specific heat capacity. Secondly, the phase change within a certain point in container took only 11 minutes,

therefore time step of simulations needs to be in minutes. Thirdly, the heat loss value of  $U = 1.75 \text{ W}/(\text{m}^2 \cdot \text{K})$  of the tank was calculated from experimental data, which is later used in the validation of the mathematical model.

For validation of data, the model is built in TRNSYS software. TRNSYS comes with built-in components for sensible heat storage, however, there are no built-in components that can simulate PCM in the tank. During the research process, two types that can use PCM were obtained from other researchers who developed them within Solar heating & cooling programme (IEA SHC) Task 32, Subtask C (Streicher et al., 2008). One is Type 860 and the other is Type 840. Both types are firstly validated with sensible heating experimental data. But only Type 860 is used to validate experiments with PCM because Type 840 does not support container size and count that is used in experiments. In the short-term model, the only component is the tank and the rest of the elements are for data input, output and visualization. Both of the types used enthalpy method to describe the phase change process. In Type 840 tank division in 100 layers (nodes) was used with a total height of tank being 1260 mm, each node had a height of 12.6 mm. Calculation in each time step is done between each node to account for mass flows from inlets, outlets and movement between nodes, heat flux from internal heat exchangers, auxiliary heaters, thermal conduction between neighbouring nodes, heat losses and energy exchange between the storage medium and PCM modules.

Although both of the types had been validated by the developers of the models (Bony & Citherlet, 2007; Schranzhofer, Schranzhofer, Puschnig, Heinz, & Streicher, 2006), validation of experimental system was done on Type 840 for tank with only water and on Type 860 for tank without water and tank with water and PCM. The comparison of energy removed showed that the model of Type 860 had lower numbers compared to experiment by 11 % for both cases while Type 840 had lower value by 4 % for the case without PCM. Meanwhile, the temperature change in water and PCM was found to have a good fit with  $R^2$  values above 0.9. For example, PCM temperature has an  $R^2$  value of 0.99, which suggests, that phase change in model follows the same characteristics (Fig. 2.2).

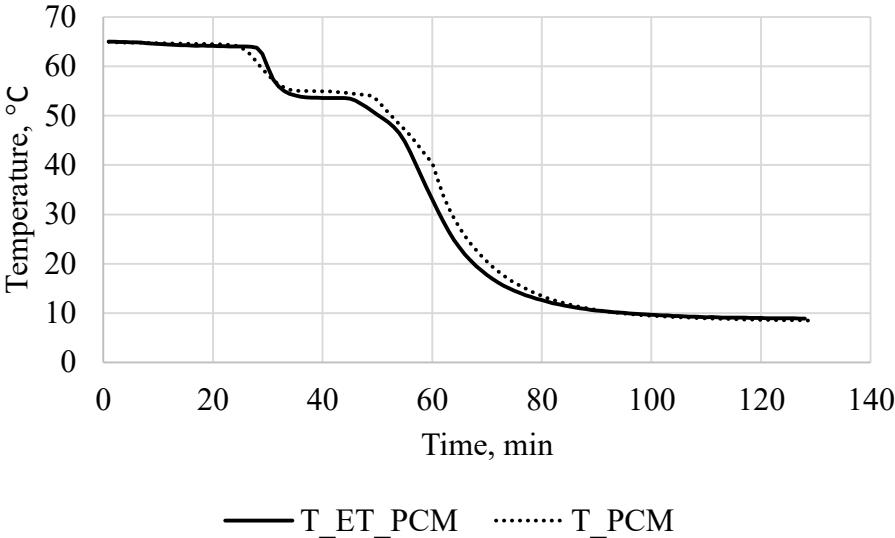

Fig. 2.2. Comparison of PCM temperature in cooling experiment and model.

Since during annual simulations cylindrical containers are used, the limitation of placement of rectangular containers in Type 840 does not have an effect, and due to better validation fit, and since it was much easier to work with it, Type 840 was chosen as the main type for annual simulations.

### 3. ANNUAL MODEL RESULTS FOR SENSITIVITY, OPTIMIZATION AND USE OF MULTIPLE PCM

From literature, it could be seen that short-term experiments and simulations showed that PCM storage tanks could provide higher energy density, however, heating in these experiments happened often in a constant manner. For PCM packed bed system application in solar domestic hot water (SDHW) systems, annual results with actual climate data are needed, and there was a lack of such information in the literature. Therefore, annual model was developed based on components validated with experimental data.

The system consists of a storage tank, SC, pump, controller and auxiliary heater (Fig. 3.1). SC area is designed as 1/60<sup>th</sup> of storage volume. Based on the experimental system, the storage tank volume is kept 353 litres. SC area accordingly is 5.8 m<sup>2</sup>. The circuit at the collector side in this model is directly connected to the tank to exclude the impact of external HEXs. Circulating pump is used to control the flow rate through SC. Heat losses, however, are reduced, to resemble commercial systems from 4.29 W/K to 2.4 W/K.

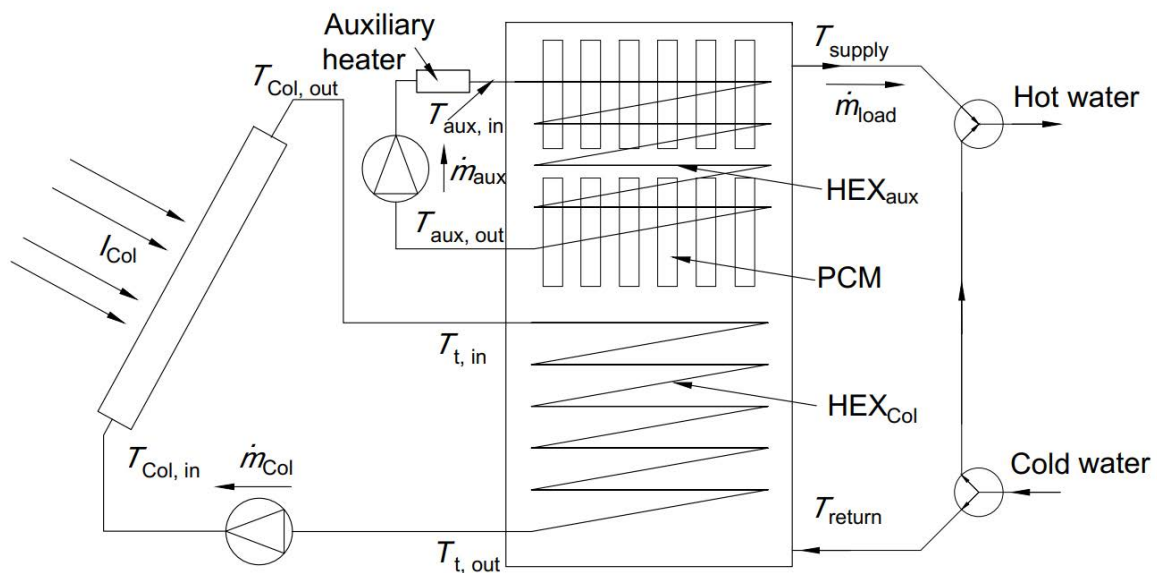

Fig. 3.1. Solar heating system used in annual simulations.

The auxiliary heater can be installed in a tank, it can be outside a tank and transfer heat with submerged HEX or it can be placed after the tank on the domestic hot water (DHW) outlet. Temperature frequency analysis is carried out to choose the most suitable design. It was found that using submerged HEX and control with dead bands provides clearer peak temperature, which could be used as a melting point of PCM and also provides more frequent fluctuations above and below this peak (Fig. 3.2). Fluctuations would be needed for PCM to solidify and melt more often. This is important, since in sensible heat temperature ranges PCM has lower specific heat compared to water, therefore, for the PCM to improve the system, it has to utilize the latent potential during phase change.



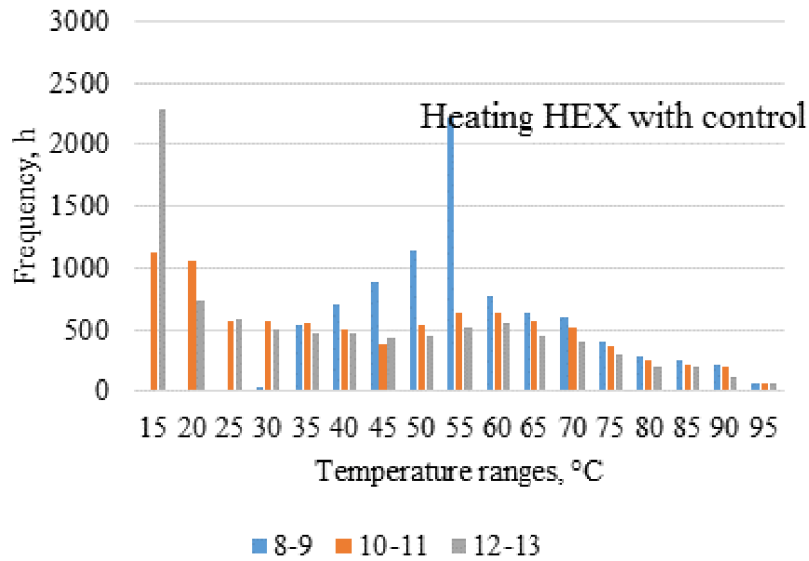

Fig. 3.2. Frequency of temperature ranges for hourly data of annual simulation without PCM and with heating HEX and dead band control.

In the annual model the PCM used has a specific heat of 1.8 kJ/(kg·K) in solid and 2.4 kJ/(kg·K) in liquid forms, latent heat of 185 kJ/kg, the density of 1100 kg/m<sup>3</sup> and thermal conductivity of 4.5 W/(m·K). 150 cylindrical aluminium containers with an outside diameter of 40 mm and inside diameter of 38 mm are used.

Consumer usage is based on the assumption that the system is for 3 persons, with average daily water consumption of 50 litres per person, adding to 150 litres per day. The usage profile is with constant set temperature at the outlet, which is achieved by mixing hot water available at the top of the tank and cold water from the grid. The profile is based on European reference tapping cycles (Bonk, 2012).

To find out the main parameters that affect the PCM SDHW system, a sensitivity analysis is carried out. Although there are at least 12 aspects that affect the system, 5 aspects are chosen for analysis with the one-at-a-time method. The following aspects are being analysed: 1) PCM thermal conductivity; 2) melting point; 3) number of containers; 4) latent heat; 5) heater set point. For each aspect, there are variances of +5 %, +10 %, -5 % and -10 % from the base case.

Sensitivity analysis showed that the main aspects that affect the performance of the system are melting point and heater setpoint (Fig. 3.3). Lower melting point compared to base scenario reduces solar collector efficiency and solar fraction, because PCM, 99.7 % of the year, is in fully melted state and works as a sensible heat storage medium with inferior thermal properties compared to water. The higher melting point had an insignificant increase in SF. Lower heater setpoint increases solar collector efficiency and solar fraction, since the store is cooler, which reduces heat losses by 7.3 %. Reduced heater setpoint by 10 % reduces average inlet temperature at the collector from 48.5 °C in the base scenario to 47.6 °C (reduction by 1.8 %), which in turn increases solar collector efficiency by 2 %. However, due to reduced setpoint, the DHW temperature falls below 54 °C more than 50 % of the supply period of a year. Thermal conductivity and number of containers have a linear impact in the range analysed, and both affect solar fraction by less than 0.2 % with a maximum change of 10 %.

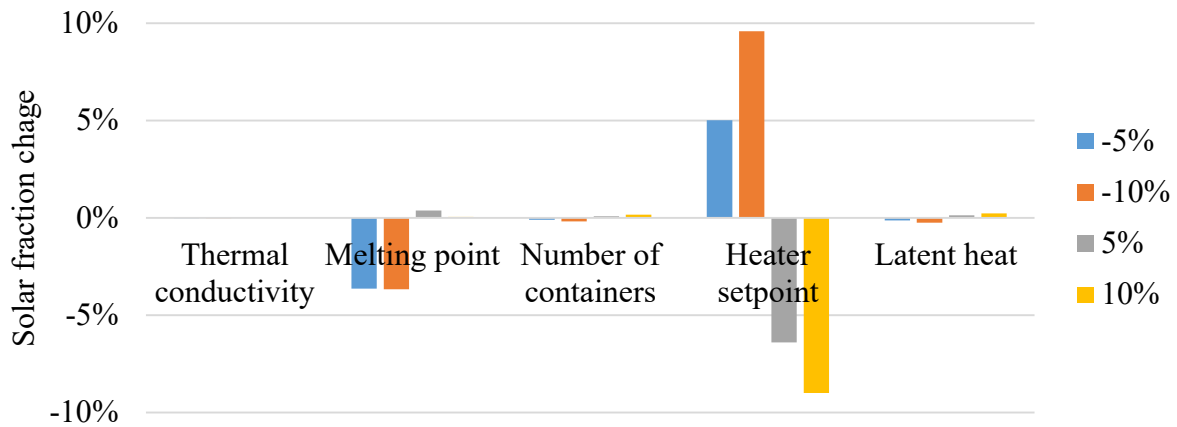

Fig. 3.3. Solar fraction change depending on variances of aspects.

Based on sensitivity analysis the main aspects that affect the performance of the system are melting point and heater setpoint. Heater setpoint has a limitation that it needs to be above the DHW set-point. Therefore, the setpoint itself for the heater is restricted within the limitations, however, heater control strategy can be used to optimize the system. In optimization scenario, heater loop delivers heat based on the temperature of PCM not water, which means that it is possible to make sure that PCM fully melts and fully solidifies. Problems with this control strategy were that for PCM to solidify, the temperature of the tank had to cool down below setpoint for DHW ( $T_{DHW}$ ), resulting in a period of a year where setpoint temperature of 55 °C was not reached. Optimization of dead band value and heater power was analysed, and it was found that 4 °C dead band is the optimal choice from the ones that were analysed.

Comparing optimized base scenario, in which PCM with melting point of 55 °C is used at the top of the tank, with the scenario without PCM, annual SF was increased by 6 %, collector efficiency by 3.5 % and decreased annual auxiliary heating by 11.6 % with increase in periods where target DHW temperature is not reached. The different control method in combination with PCM affects the system by reducing auxiliary heating, which results in lower average tank temperature, smaller heat losses, more energy obtained from solar collectors and larger solar fraction.

Three scenarios were analysed for multiple PCM utilization. The first one is based on temperature frequency analysis from the system without PCM, which found high temperature frequency at two positions, which result in inverse placement – 55 °C PCM at the top and 60 °C PCM at the position of solar HEX, at the lower part of the tank. This scenario is analysed since one of the initial ideas was that the use of temperature frequency information without PCM could be a tool for existing tank manufacturers to help choosing appropriate melting points. The second scenario is from temperature frequency data from the case with a single PCM of 55 °C at the top. In this case, 55 °C at the top and 35 °C at the bottom was found to be the possible positions. The third scenario is standard stratification placement with PCMs with melting points of 55 °C at the top, 45 °C at the middle and 35 °C at the bottom.

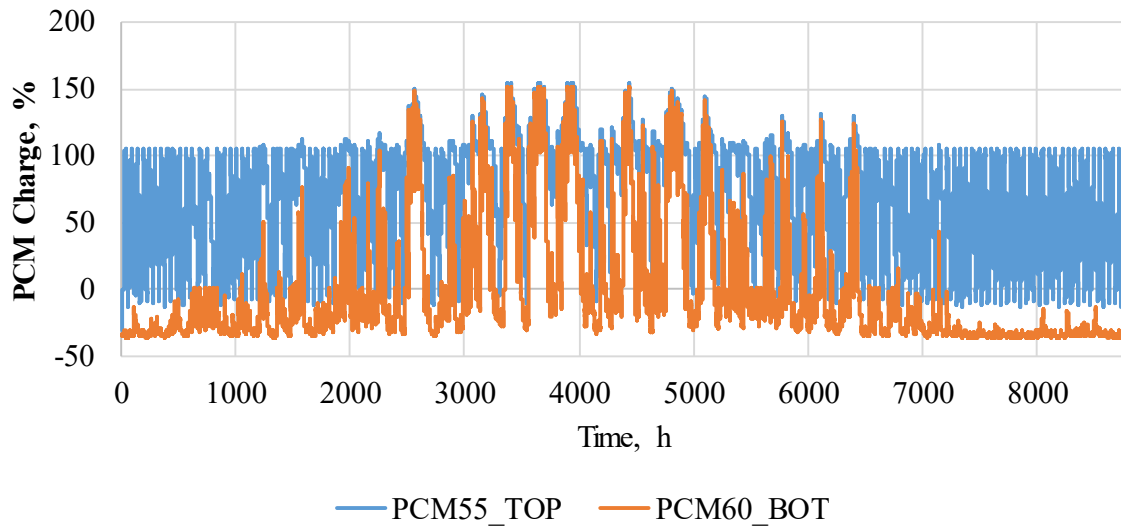

Fig. 3.4. PCM charge throughout one year for PCM\_TB placement with PCM55 at the top and PCM60 at the bottom.

As can be seen in Fig. 3.4, PCM with a melting point of 55 °C (PCM55) fully charges and discharges during periods with less solar radiation when heating is dominated by the auxiliary heater, while bottom PCM changes phase more often during summer with more solar radiation, even with a melting point of 60 °C. In this way, multiple PCMs can ensure a wider period of the year with some of the PCM changing phase. However, absolute results showed that multiple PCM system does not perform better than the system with single PCM at the top in the SDHW system.

Based on the literature analysis, high energy density thermal energy storage systems could increase solar energy adaptation rate, and development of some type of guidelines could help. However, the results of simulations show that there are a large number of variables that need to be considered to obtain increased performance in packed bed PCM storage and information, therefore, a deeper analysis would be needed for individual applications. Therefore, more general guidelines are prepared to help to select suitable PCM based on materials in contact, the density of working fluid and temperature profile.

## GENERAL CONCLUSIONS

1. Within the Thesis, experimental analysis and mathematical simulation within TRNSYS of a thermal energy storage system with PCMs have been carried out. Short term analysis has been carried out experimentally and obtained data were used to validate the short-term simulation model. Based on the results of the short-term analysis, a long-term model was developed to analyse PCM within the SDHW system in Latvia's climate conditions.
2. Sensitivity analysis has been carried by applying a one-at-a-time method for five aspects – PCM thermal conductivity, melting point, number of containers, heater setpoint and latent heat; and four variances: –10 %, –5 %, +5 %, and +10 %. Sensitivity analysis results show that PCM melting point and auxiliary heater setpoint have the highest impact on solar fraction and collector efficiency.
3. During optimization of the thermal storage with PCM, it was found that to obtain full PCM charge and discharge, the auxiliary heater must be controlled by a temperature sensor placed inside PCM. With optimized control the energy used by auxiliary heater was reduced by 148 kWh, however, also the energy delivered to the load was reduced by 42 kWh. Reduced energy at the load leads to the problem of water temperature of the hot water being below setpoint of 55 °C in 10 % of the period of working time. Meanwhile, the combination of PCM and reduced auxiliary heating by 11 % increased SF by 6 % and collector efficiency by 3.5 %.
4. The hypothesis of the Thesis was based on the theoretical energy density of the tank, which calculated for a given temperature range (40 K) is higher for multiple PCM arrangement. Annual simulation results support the hypothesis by achieving higher solar fraction and solar collector efficiency by using stratified PCMs compared to the system without PCMs. However, it can also be concluded that the theoretical energy density of the tank cannot be used to evaluate the potential of PCM in solar domestic hot water systems. Arrangement with three PCMs achieved by 26.3 % higher energy density compared to a single PCM system but annual simulations had a lower solar fraction and collector efficiency.

## REFERENCES

- Albatayneh, A., Alterman, D., Page, A., & Moghtaderi, B. (2017). The Significance of Temperature Based Approach Over the Energy Based Approaches in the Buildings Thermal Assessment, *19*, 39–50. <https://doi.org/10.1515/rtuct-2017-0004>
- Ansone, A., Dzikevics, M., & Zandeckis, A. (2016). Energy Accumulation Using Encapsulated Phase Change Materials with Recycled Material Components. In *Energy Procedia* (Vol. 95). <https://doi.org/10.1016/j.egypro.2016.09.037>
- Baldwin, C., & Cruickshank, C. A. (2016). Using TRNSYS Types 4, 60 and 534 to model residential cold thermal storage units using water and water/glycol solutions. In *eSIM 2016 Conference Proceedings*. Retrieved from <http://www.ibpsa.org/proceedings/eSimPapers/2016/52-77-eSim2016.pdf>
- Barreneche, C., Navarro, M. E., Cabeza, L. F., & Fernández, A. I. (2015). New database to select phase change materials: Chemical nature, properties, and applications. *Journal of Energy Storage*, *3*, 18–24. <https://doi.org/10.1016/j.est.2015.08.003>
- Belmonte, J. F., Eguía, P., Molina, A. E., Almendros-Ibáñez, J. A., & Salgado, R. (2015). A simplified method for modeling the thermal performance of storage tanks containing PCMs. <https://doi.org/10.1016/j.applthermaleng.2015.10.111>
- Bonk, S. (2012). Methodology for the Assessment of the Hot Water Comfort of Factory Made Systems and Custom Built Systems.
- Bony, J., & Citherlet, S. (2007). Numerical model and experimental validation of heat storage with phase change materials. *Energy and Buildings*, *39*(10), 1065–1072. <https://doi.org/10.1016/j.enbuild.2006.10.017>
- Bourne, S., & Novoselac, A. (2015). PCM-based High-density Thermal Storage Systems for Residential and Small Commercial Retrofit Applications. *Procedia Engineering*, *121*, 536–543. <https://doi.org/10.1016/j.proeng.2015.08.1025>
- Buttitta, G., Serale, G., & Cascone, Y. (2015). Enthalpy-temperature evaluation of slurry phase change materials with T-history method. *Energy Procedia*, *78*, 1877–1882. <https://doi.org/10.1016/j.egypro.2015.11.352>
- Cabeza, L. F., Castell, A., Barreneche, C., De Gracia, A., & Fernández, A. I. (2011). Materials used as PCM in thermal energy storage in buildings: A review. *Renewable and Sustainable Energy Reviews*, *15*(3), 1675–1695. <https://doi.org/10.1016/j.rser.2010.11.018>
- Calderón, A., Barreneche, C., Hernández-Valle, K., Galindo, E., Segarra, M., & Fernández, A. I. (2019). Where is Thermal Energy Storage (TES) research going? – A bibliometric analysis. *Solar Energy*. <https://doi.org/10.1016/J.SOLENER.2019.01.050>
- Central Statistical Bureau of Latvia. (2019). Environment and Energy. Retrieved January 1, 2019, from [https://data1.csb.gov.lv/pxweb/lv/vide/vide\\_\\_energetika\\_\\_ikgad/ENG150.px/](https://data1.csb.gov.lv/pxweb/lv/vide/vide__energetika__ikgad/ENG150.px/)
- Drück, H., & habil Müller-Steinhagen Pfaffenwaldring, D.-I. H. (2006). *MULTIPOINT Store - Model for TRNSYS Stratified fluid storage tank with four internal heat exchangers, ten connections for direct charge and discharge and an internal electrical heater Type 340*. Stuttgart. <https://doi.org/10.03.06>
- European Solar Thermal Industry Federation. (2017). *Solar Heat Markets in Europe: Trends and Market Statistics 2017*. Retrieved from [http://solarheateurope.eu/wp-content/uploads/2017/11/Solar\\_Heat\\_Markets\\_2017-Web-based-version.pdf](http://solarheateurope.eu/wp-content/uploads/2017/11/Solar_Heat_Markets_2017-Web-based-version.pdf)
- Eurostat. (2018). Energy consumption in households - Statistics Explained. Retrieved February 5, 2019, from [https://ec.europa.eu/eurostat/statistics-explained/index.php/Energy\\_consumption\\_in\\_households#cite\\_note-1](https://ec.europa.eu/eurostat/statistics-explained/index.php/Energy_consumption_in_households#cite_note-1)
- Lin, Y., Jia, Y., Alva, G., & Fang, G. (2017). Review on thermal conductivity enhancement, thermal properties and applications of phase change materials in thermal energy storage.

- Renewable and Sustainable Energy Reviews*, (September), 0–1.  
<https://doi.org/10.1016/j.rser.2017.10.002>
- Najafian, A., Haghghat, F., & Moreau, A. (2015). Integration of PCM in domestic hot water tanks: Optimization for shifting peak demand. *Energy and Buildings*, 106, 59–64.  
<https://doi.org/10.1016/j.enbuild.2015.05.036>
- Niemenmaa, V., Happach, B., Kubat, J., Otto, J., Pirelli, L., Simeonova, R., ... Coelho, J. (2018). *Special Report. Air pollution*. Retrieved from  
[https://www.eca.europa.eu/Lists/ECADocuments/SR18\\_23/SR\\_AIR\\_QUALITY\\_EN.pdf](https://www.eca.europa.eu/Lists/ECADocuments/SR18_23/SR_AIR_QUALITY_EN.pdf)
- Reddy, K. S., Mudgal, V., & Mallick, T. K. (2018). Review of latent heat thermal energy storage for improved material stability and effective load management. *Journal of Energy Storage*, 15, 205–227. <https://doi.org/10.1016/J.EST.2017.11.005>
- Salunkhe, P. B., & Shembekar, P. S. (2012). A review on effect of phase change material encapsulation on the thermal performance of a system. *Renewable and Sustainable Energy Reviews*, 16(8), 5603–5616. <https://doi.org/10.1016/j.rser.2012.05.037>
- Sarier, N., & Onder, E. (2012). Organic phase change materials and their textile applications: An overview. *Thermochimica Acta*, 540, 7–60. <https://doi.org/10.1016/j.tca.2012.04.013>
- Schranzhofer, H., Schranzhofer, H., Puschnig, P., Heinz, A., & Streicher, W. (2006). Validation of a TRNSYS simulation model for PCM energy storage and PCM wall construction elements, Ecstock06 proceedings. Retrieved from  
<http://citeseerx.ist.psu.edu/viewdoc/summary?doi=10.1.1.520.6262>
- Streicher, W., Bony, J., Citherlet, S., Heinz, A., Pusching, P., Schramzhofer, H., & Schultz, J. M. (2008). Simulation models of PCM storage units. *A Report of IEA Solar Heating and Cooling ...*, (March). Retrieved from  
<http://ww.iaa-shc.org/publications/downloads/task32-c5.pdf>
- Terziotti, L. T., Sweet, M. L., & McLeskey, J. T. (2012). Modeling seasonal solar thermal energy storage in a large urban residential building using TRNSYS 16. *Energy and Buildings*, 45, 28–31. <https://doi.org/10.1016/j.enbuild.2011.10.023>
- Weiss, W., & Biermayr, P. (2008). *Potential of Solar Thermal in Europe*. Vienna. Retrieved from [www.estif.org](http://www.estif.org)
- Weiss, W., & Spork-Dur, M. (2019). *Solar Heat Worldwide*. 8200 Gleisdorf, Austria.